

Fire Performance Testing of an External Cladding System
BS 8414-2:2015 + A1:2017

Test Report

Prepared for : Kingspan Insulation Ltd.
Project : System Development
Report No. : DLR1547 Rev.0
Sample : 100mm Kingspan Kooltherm K15 with Dri-Design Aluminium Cassette

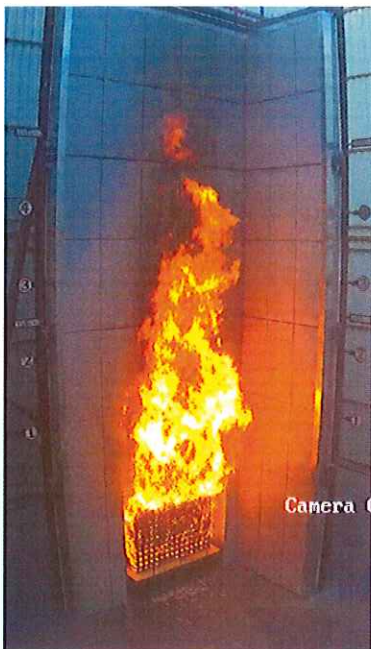

4559

September 2018

Contents

1.	Introduction	4
1.1	Purpose of Testing	4
1.2	Terms and Definitions	5
2.	Test Summary	6
3.	Description of the Test Sample	7
4.	Test Apparatus	11
4.1	Test Rig	11
4.2	Heat Source	11
4.3	Thermocouples	11
4.4	Audio Visual Equipment	12
5.	Test Procedures	15
5.1	Testing	15
5.2	Post-test Examination	15
6.	Test Data / Observations	16
6.1	Post-test Examination	22

Table Index

Table 1	Observations	6
Table 2	System Details	9
Table 3	Visual Observations During the Test	16
Table 4	Post-test Observations	22
Table 5	Document Status	45

Figure Index

Figure 1	Photo DLP C2753J/2731 External View of the Test Sample	8
Figure 2	Schematic View of the Test Rig	12
Figure 3	Thermocouple, Cavity Barrier Locations & Panel Numbering	13
Figure 4	Level 2 Section Drawings Showing the Thermocouple Locations	14
Figure 5	Thermocouple Readings on Level 1 - External	18
Figure 6	Thermocouple Readings on Level 2 – External	18
Figure 7	Thermocouple Readings on Level 2 – Internal (Cavity)	19
Figure 8	Thermocouple Readings on Level 2 – Internal (Mid-depth of 100mm Kingspan Kooltherm K15 Insulation)	19
Figure 9	Thermocouple Readings on Level 2 – Internal (Mid-depth of 12mm Versapanel Cement Particle Board)	20
Figure 10	Thermocouple Readings on Level 2 – Internal (Mid-depth of 100mm Kingframe SFS)	20
Figure 11	Thermocouple Readings on Level 2 – Internal (Mid-depth of 2 layers of 12.5mm Plaster Board)	21
Figure 12	Area Map Showing the Condition of the Sample After the Test	25

Appendices

Photographs

Drawings

1. Introduction

This report describes the fire performance test carried out at Al Futtaim Exova (AFE) laboratory in Dubai at the request of:

Kingspan Insulation Ltd,
Pembridge, Leominster,
Herefordshire, England.

Client contact: highrisetechnical@kingspan.com Contact number: +44 1544 387 382

AFE Job/Sample Number: PD 106193 / C2753J

The test sample consisted of external wall cladding system (100mm Kingspan Kooltherm K15 with Dri-Design aluminium cassette) installed by Kingspan Insulation Ltd.

This test report is personal to the client, confidential, non-assignable and shall not be reproduced, except in full, without prior written approval of AFE.

1.1 Purpose of Testing

The test was carried out on 5th August 2018 to determine the fire performance of a cladding panel system fixed on to steel frame substrate when exposed to external fire under controlled conditions. The test method was in accordance with AFE test method statement DMC2753J/MSrev0, which was in accordance with the following standards:

- ▶ BS 8414-2: 2015 + A1:2017

This test report relates only to the actual sample as tested and described herein.

The tests were witnessed wholly or in part by:

Adrian Brazier	-	Kingspan Insulation Ltd.
Ian Hughes	-	Kingspan Insulation Ltd.
Gary Nicholson	-	Kingspan Insulation Ltd.

The test was supervised and conducted by Arun Kumar Murugan of Al Futtaim Exova.

1.2 Terms and Definitions

1.2.1 Level 1 Height

2500mm above the top of the combustion chamber opening on the test apparatus.

Refer to section 4 for details.

1.2.2 Level 2 Height

5000mm above the top of the combustion chamber opening on the test apparatus.

Refer to section 4 for details.

1.2.3 Start Temperature, T_s

Mean temperature of the thermocouples at Level 1, five minutes prior to ignition of the heat source.

1.2.4 Start Time, t_s

Time when the temperature recorded by any external thermocouple at Level 1 equals or exceeds 200°C above T_s and remains above this value for at least 30 seconds.

2. Test Summary

The cladding system was tested in accordance with BS 8414-2:2015 + A1:2017 without any early termination of the test.

Table 1 Observations

See Figure 3 on page 13 and Figure 4 on page 4 for the thermocouple locations & numbers.

Parameters	Temperature Data / Observations
T _s , start temperature	28°C
t _s , start time	66 seconds after ignition of the crib (thermocouple 3)
Peak temperature & time at Level 2 (External)	944°C at 990 seconds from t _s (thermocouple 12)
Peak temperature / time at Level 2 (Mid-depth of cavity)	965°C at 981 seconds from t _s (thermocouple 20)
Peak temperature / time at Level 2 (Mid-depth of 100mm Kingspan Kooltherm K15 Insulation)	911°C at 1752 seconds from t _s (thermocouple 26)
Peak temperature / time at Level 2 (Mid-depth of 12mm Versapanel Cement Particle Board)	795°C at 2688 seconds from t _s (thermocouple 37)
Peak temperature / time at Level 2 (Mid-depth of 100mm SFS)	191°C at 2785 seconds from t _s (thermocouple 45)
Peak temperature / time at Level 2 (Mid-depth of 2 layers of 12.5mm Plaster Board)	139°C at 936 seconds from t _s (thermocouple 52)

For full details refer to Section 6.

The above results are valid only for the conditions under which the tests were conducted.

3. Description of the Test Sample

The test specimen build up comprised of:

- ❖ 2 layers of 12.5mm plaster boards.
- ❖ Kingframe SFS (steel framing system)
- ❖ 12mm thick Versapanel cement particle board
- ❖ Siderise RH25G 90/30 horizontal open state cavity barrier.
- ❖ Siderise RSV-90/30 vertical cavity barrier.
- ❖ Siderise open state cassette insert
- ❖ 100mm Kingspan Kooltherm K15 insulation.
- ❖ Aluminium support angle and railings
- ❖ Benchmark Dri-Design 2mm aluminium cassette

The sample dimensions were:

Main wall - 3230 wide x 9010mm high.

Wing wall -1680mm wide x 9010mm high.

The top termination of the cladding system was closed with 2mm thick aluminium sheet. The main wall and wing wall side were partially closed with 2mm aluminium sheet. The interface between the cladding system and the combustion chamber was covered with 5mm thick aluminium pod. The distance of the finished face of the wing wall to the side opening of the combustion chamber was 290mm.

Photo DLP C2753J/2731 below shows an external view of the sample.

Figure 1 Photo DLP C2753J/2731 External View of the Test Sample



The system components are mentioned in Table 2. Refer to the drawings in Appendix B for sample construction details and dimensions.

Table 2 System Details

Component	Description	Installation Details
Internal wall board	2 nos. of 12.5mm plaster board. See photo DLP C2753J/2383 in Appendix A.	Plaster boards were fixed to the SFS with flat head screws.
Steel framing system (SFS)	Kingframe SFS (steel framing system) comprising galvanized cold formed steel 'C' and 'U' sections with 100x50mm studs. See photos DLP C2753J/2383 & DLP C2753J/2384 in Appendix A.	The tracks were fixed to the concrete beams with HTF-6.3 x 45mm carbon steel screws. The studs were fixed to the tracks with DF3-SS-5.5x55mm carbon steel screws.
Sheathing board	12mm thick Versapanel cement particle board manufactured by Euroform. See photo DLP C2753J/2583 in Appendix A.	Cement particle boards were fixed to the SFS with DF3-CF-5.5x22mm carbon steel screws.
Breather membrane	Nilvent breathable membrane. See photo DLP C2753J/3180 in Appendix A.	Nilvent breathable membrane was provided to the face of the Cement board.
Bracket and Railings	Aluminium angle bracket: 130x100x3mm aluminium support angle Railings: 70x40x2mm aluminium horizontal rail See photos DLP C2753J/2685 & DLP C2753J/3180 in Appendix A.	Aluminium support angle brackets were fixed to SFS through the sheathing board with SX5/20-30-S16-5.5x52mm fasteners. Aluminium horizontal rails were fixed to the aluminium support angle with SN5-12-S-5.5x22mm fasteners.
Cavity barrier	Horizontal cavity barrier: Siderise RH25G-90/30, open state cavity barrier, 125mm in depth (25mm closure) See photos DLP C2753J/3180 & DLP C2753J/2661 in Appendix A.	The horizontal cavity barriers were fixed to the concrete slab with HTF-6.3 x 45mm carbon steel screws and to the sheathing board with DF3-SS-5.5x35mm steel screws. 4 nos. of horizontal cavity barriers were installed on the main wall and wing wall at 150mm, 2375mm, 4875mm and 6890mm above combustion chamber.
	Vertical cavity barrier: Siderise RSV-90/30 vertical cavity barrier, 160mm depth. See photos DLP C2753J/3180 & DLP C2753J/2661 in Appendix A.	The vertical cavity barriers were fixed to the SFS through the sheathing board with DF3-SS-5.5x35mm steel screws. 2 nos. of vertical cavity barrier were installed on the main wall and 1 no of vertical cavity barriers was installed on the wing wall.

	Cassette insert: Siderise open state cassette insert (OSCI) 100x30mm See photo DLP C2753J/2674 in Appendix A.	Siderise inserts were placed at the folding of the aluminium cassette panels at the cavity barrier locations.
Thermal Insulation	100mm thick Kingspan Kooltherm K15 insulation. See photo DLP C2753J/2685 in Appendix A.	Kingspan Kooltherm K15 insulations were fixed to the sheathing boards with plastic and steel pins. Self-adhesive foil tape was provided at the joints, screw heads, perimeter of the insulation boards
Panels	Benchmark Dri-Design 2mm aluminium cassette panel. Finish: PPC RAL 9006	Aluminium cassette panels were fixed to the horizontal railings with Benchmark Dri-Design base J BMDD-JEXT05SMFAC/P and Benchmark KSMR-ALU rivets.

Material information described in Table 2 is as supplied by Kingspan Insulation Ltd.

AFE was not involved in the design, procurement, installation, specification and verification of the materials / properties or system.

Sample installation

AFE monitored the installation of the sample based on the drawings supplied by Kingspan Insulation Ltd. which are included in Appendix B of this report. Any deviation in the installation from these drawings were recorded and reported.

Date of installation: 27 July to 2 August 2018

Ambient temperature range: 27 - 36°C

4. Test Apparatus

4.1 Test Rig

The test specimen was installed on a purpose-built test rig constructed by AFE as per the BS 8414-2:2015 + A1:2017 standard.

The test apparatus had a vertical structural steel test frame, with a vertical main test wall and a vertical return wall (wing) at a 90° angle to, and at one side of the main test wall. The main wall was provided with a combustion chamber with an opening of 2000mm x 2000mm. The test facility was capable of enduring the effects of the test procedure without itself suffering undue damage or distortion. The main wall had a width of 3800mm and the wing wall with a width of 2300mm. The total height of the test rig was 9300mm.

Refer to Figure 2 below for a schematic diagram of the test rig.

4.2 Heat Source

A timber crib, 1500mm x 1000mm in plane and 1000mm in height, was constructed using Pinus Silvestris softwood sticks as described in BS 8414-2:2015 + A1:2017 with a first layer consisting of 10 long sticks of 1500mm. The next layer consisted of 15 short sticks was evenly distributed to cover an area of 1500mm x 1000mm.

The process was repeated to give a total of 20 layers of sticks, giving a nominal height of 1000mm. The crib was constructed on a solid steel platform positioned 400mm above the floor of the combustion chamber and placed centrally and displaced 100mm from the back wall of the chamber.

The crib was ignited using 16 strips of low density fibreboard, soaked for 5 minutes in 5 litres of white spirit.

4.3 Thermocouples

All thermocouples used conformed to BS EN 60584-1:2013, Type K (Chromel / Alumel). The thermocouples were mineral insulated and had a nominal 1.5mm diameter with insulated junctions. Data acquisition was performed at 3 second intervals.

The locations of the thermocouples on the specimen were as shown in Figure 3.

4.3.1 External thermocouples at Levels 1 and 2

Thermocouples were positioned in front of the main test wall face on the centre line and at 500 mm and 1000 mm each side of the centre line of the combustion chamber (five locations). Thermocouples were also positioned in front of the wing test wall face at 150 mm, 600 mm and 1 050 mm from the finished face of the main test wall face (three locations).

4.3.2 Internal thermocouple locations at Level 2

Thermocouples were positioned within each layer (greater than 10mm thick) of the main test wall face on the centre line and at 500mm and 1000mm each side of the centre line of the combustion chamber (five locations). Thermocouples were also positioned within each layer (greater than 10mm thick) of the wing

test wall at 150mm, 600mm and 1050mm from the finished face of the main test wall face (three locations).

4.4 Audio Visual Equipment

A continuous audio-visual record of the condition of the full height of the test faces was taken throughout the period of the test. Both the external and internal faces of the test specimen was monitored.

Figure 2 Schematic View of the Test Rig

Note: All dimensions are in mm, the drawing is not to scale

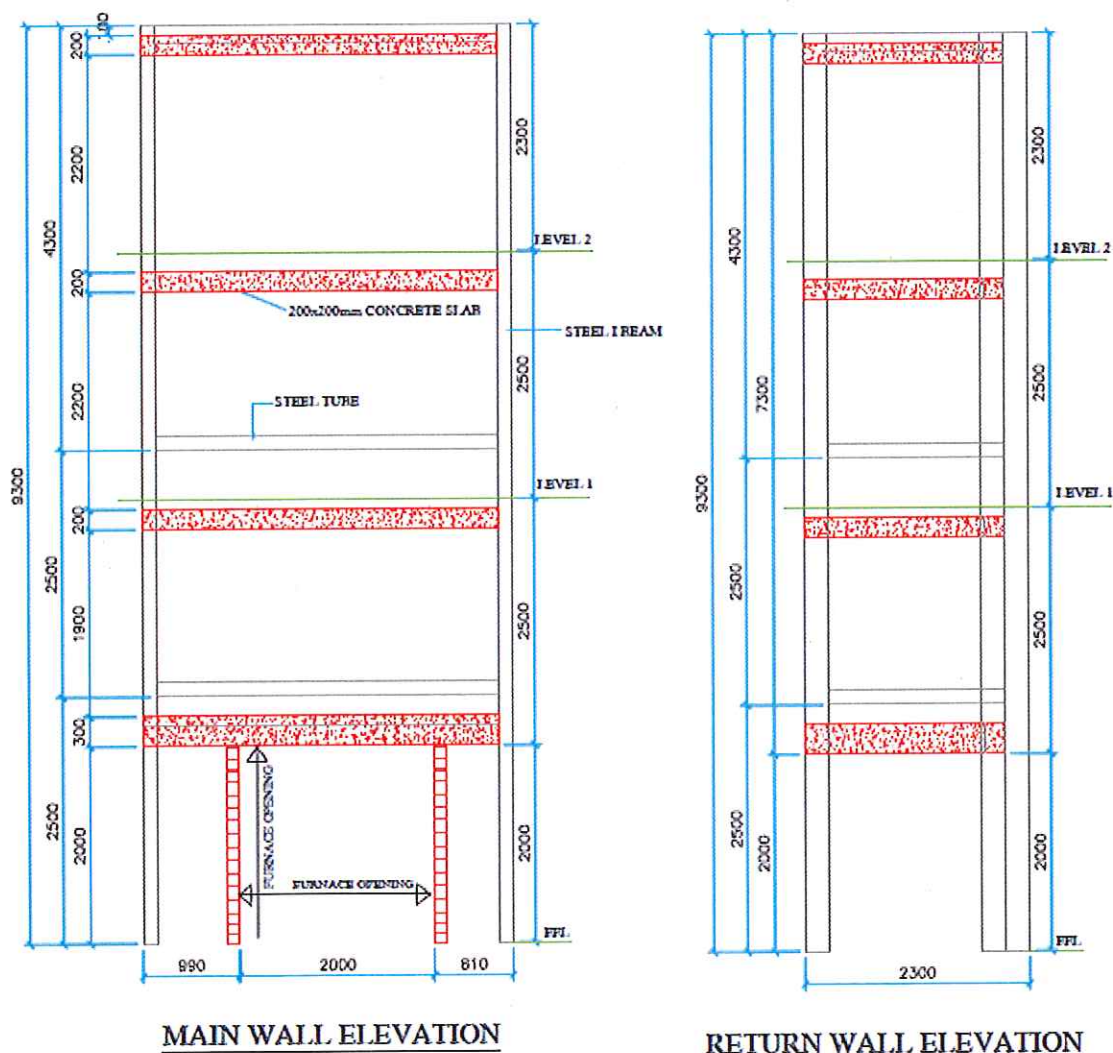

Figure 3 Thermocouple, Cavity Barrier Locations & Panel Numbering

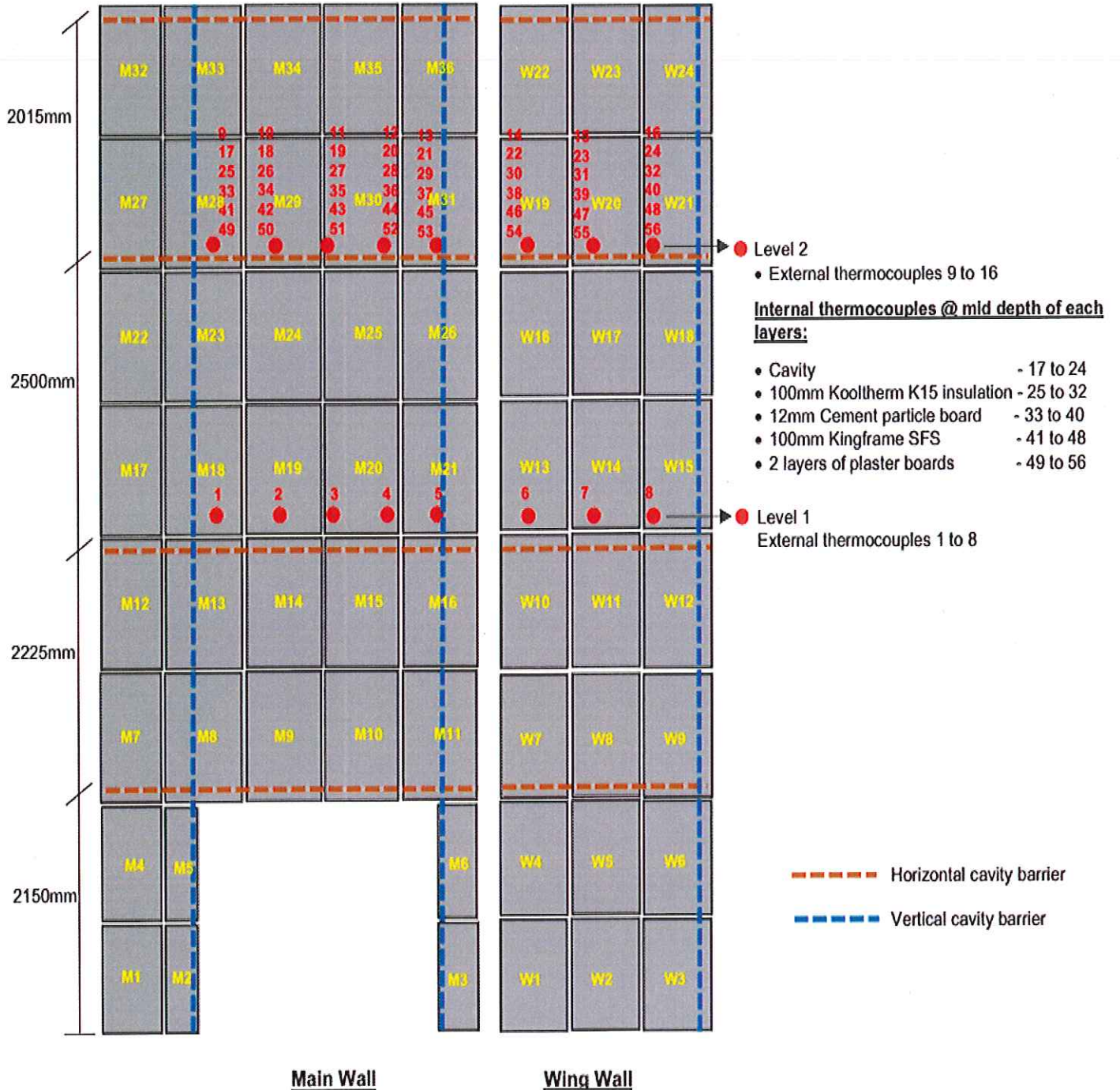
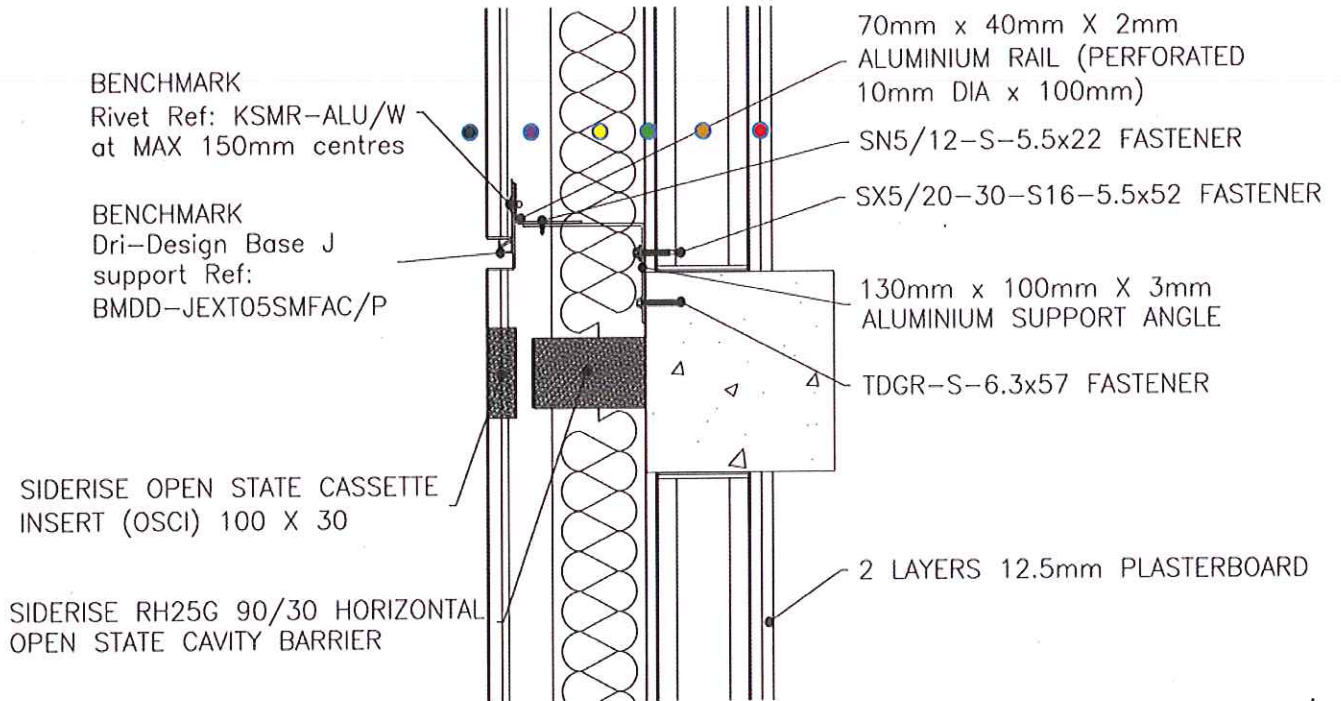

Figure 4 Level 2 Section Drawings Showing the Thermocouple Locations



● External thermocouples	- 9 to 16
● Cavity	- 17 to 24
● 100mm Kingspan Kooltherm K15 Insulation	- 25 to 32
● 12mm Versapanel cement particle board	- 33 to 40
● 100mm Kingframe SFS	- 41 to 48
● 2 layers of 12.5mm plaster boards	- 49 to 56

5. Test Procedures

5.1 Testing

The environmental conditions were recorded.

The data acquisition and video recording was started 5 minutes prior to ignition of the fuel source. Then fuel source was ignited.

Significant events were recorded, including;

- changes in flaming conditions
- change in the mechanical behaviour of the cladding system
- the detachment of any part of the sample
- fire penetration through any fire stops in the cladding system

The heat source was extinguished 30 minutes after ignition. The data acquisition was continued to 60 minutes from ignition.

5.2 Post-test Examination

After the test was terminated, the sample was allowed to cool. The sample was then examined for damage, including the following.

- Spalling
- Melting
- Deformation
- Delamination
- The extent of flame spread over the surface of the cladding system
- The extent of flame spread and/or damage within intermediate layers
- An estimate of flame spread and/or damage within cavities
- The extent to which the external face of the cladding system has burnt away or become detached
- Details of any collapse or partial collapse

Smoke staining and discolouration were not considered damage in this context.

6. Test Data / Observations

The sample conditioned period was not specified. The ambient temperature was in the range 27°C - 36°C during installation.

Installation start date: 27 July '18

Date of testing: 5 August '18

Ambient temperature: 28°C

Wind speed recorded at the start of the test: 0.2m/s

The table below summarises the observations during the test.

Table 3 Visual Observations During the Test

Time	Seconds	Observation	Photo Reference
06:15:33	N/A	Ignition of crib	-
06:16:10	N/A	Flame reached above the combustion chamber.	-
06:16:39	00	Start time t_s , 249°C ($\geq T_s + 200^\circ\text{C}$) at thermocouple 3, Level 1 (main wall).	-
06:17:45	66	Flame tip at 3m above the combustion chamber.	-
06:18:25	106	Coating of panels M9, M10, M14 & M15 started to burn off.	-
06:19:23	164	Coating of panels M19 & M20 started to burn off.	DLP C2753J/0001
06:20:33	234	Self-sustained flames on the surface of panels M14 & M15.	-
06:21:14	275	Debris started falling off the main wall.	-
06:21:17	278	Coating of panels M24 & M25 started to burn off.	-
06:22:35	356	Self-sustained flames on the surface of panel M8.	-
06:23:17	398	Continuous falling of aluminium debris from the main wall.	-
06:23:22	403	Panels M9, M10, M14 & M15 partially melted and insulation behind the panels burning.	DLP C2753J/0002
06:23:34	415	Debris of insulation behind panel M14 fell off.	-
06:23:49	430	Self-sustained flames on the surface of panel W7.	DLP C2753J/0003
06:23:59	440	Self-sustained flames on the surface of panel W10.	-
06:24:38	479	Flaming debris fell off the main wall.	DLP C2753J/0004
06:25:22	523	Coating of panel M30 started to burn off.	-
06:25:43	544	Self-sustained flames on the surface of panel M24.	-

Time	Seconds	Observation	Photo Reference
06:26:05	566	Approximately 90% of panels M9, M10, M14 & M15 melted.	DLP C2753J/0005
06:27:12	633	Self-sustained flames at panels M7 & M8 vertical joint.	-
06:27:21	642	Panels M19 & M20 partially melted and insulation behind the panels burning.	-
06:27:27	648	Debris of insulation behind panel M25 fell off.	-
06:27:43	664	Self-sustained flames on the surface of panels W8 & W11.	-
06:28:39	710	Panels M24 & M25 partially melted and insulation behind the panels burning.	DLP C2753J/0006
06:29:14	755	Self-sustained flames on the surface of panels W13 & W14.	-
06:31:48	909	Self-sustained flames on the surface of panel W16.	-
06:32:42	963	High intensity flames on the insulation behind the panel M30.	DLP C2753J/0007
06:33:59	1040	Coating of panel M35 started to burn off.	-
06:34:58	1099	100% of the panels M19, M20, M25 & M30 consumed.	DLP C2753J/0008
06:35:17	1118	Self-sustained flames on the surface of panels W2 & W6.	-
06:36:27	1188	Self-sustained flames at panels M34 & M35 vertical joint.	-
06:38:07	1288	Flames behind panel M35.	DLP C2753J/0009
06:40:35	1436	Continuous falling of debris of insulation.	-
06:41:56	1517	Panel M35 discoloured.	-
06:42:00	1521	Flaming debris of the insulation behind panel M24 fell off.	DLP C2753J/0010
06:45:33	1734	Heat source was extinguished. Observations continued for another 30 minutes.	-
06:46:42	1803	Self-sustained flames on the insulations behind panels M21 & M30.	-
06:49:13	1954	Self-sustained flames on the insulation behind panel M24.	-
07:05:40	2941	Self-sustained flames behind panels M11 & W7 internal corner.	-
07:15:33	3534	Test was terminated 60 minutes after the ignition.	-

Figure 5 Thermocouple Readings on Level 1 - External

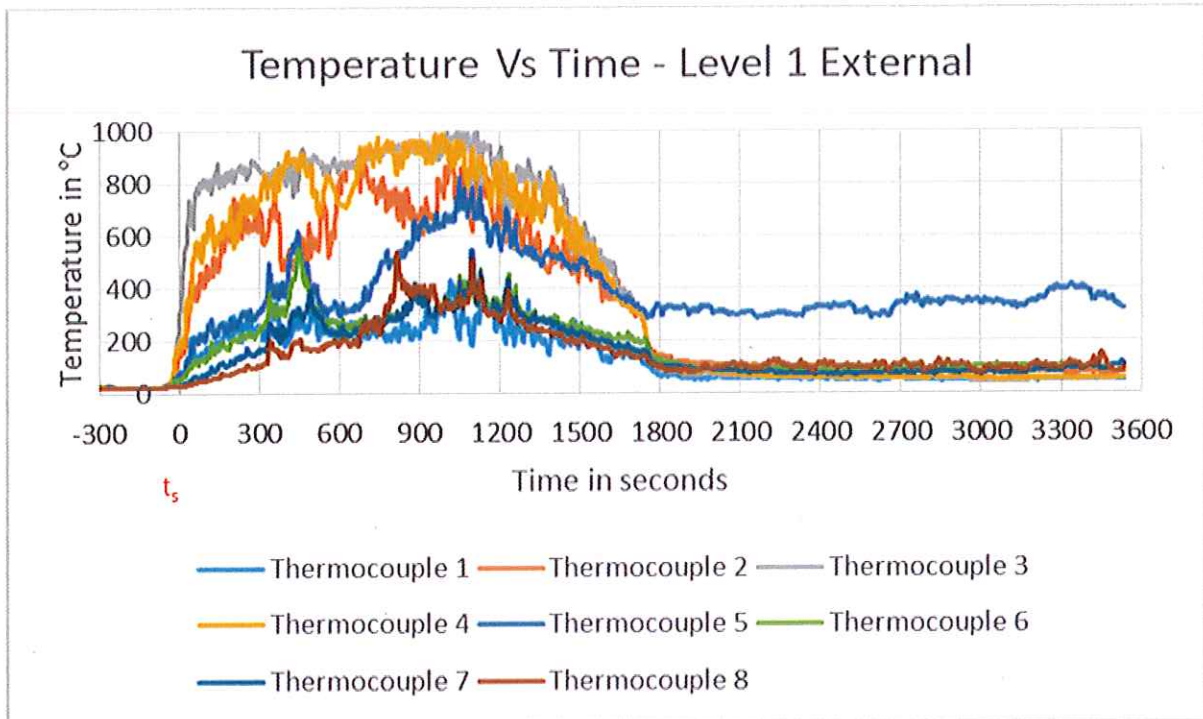

For thermocouple locations see Figure 3 & 4.

Figure 6 Thermocouple Readings on Level 2 – External

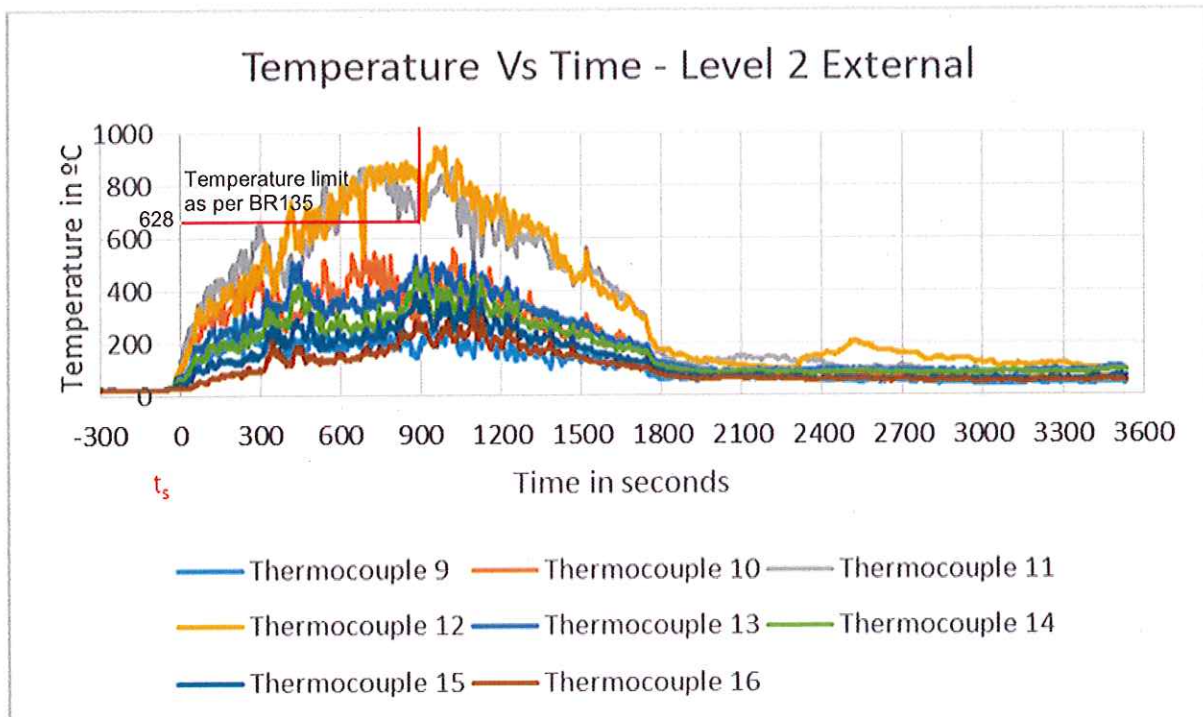

For thermocouple locations see Figure 3 & 4.

Figure 7 Thermocouple Readings on Level 2 – Internal (Cavity)

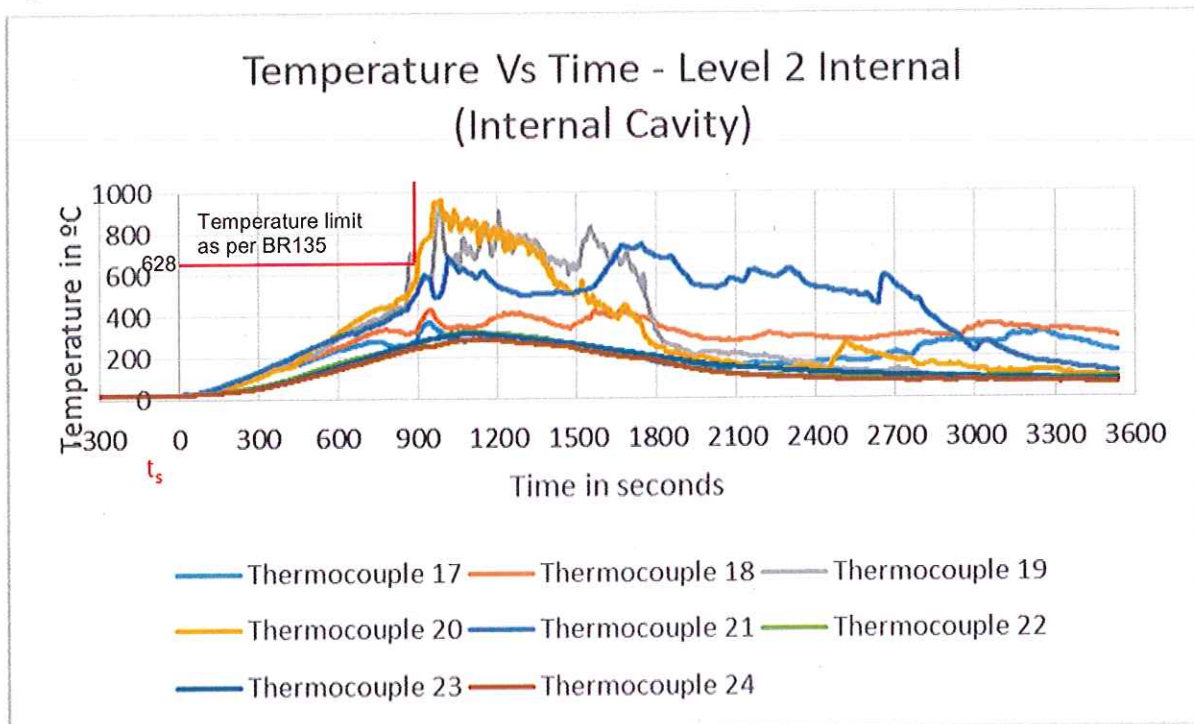

For thermocouple locations see Figure 3 & 4.

Figure 8 Thermocouple Readings on Level 2 – Internal (Mid-depth of 100mm Kingspan Kooltherm K15 Insulation)

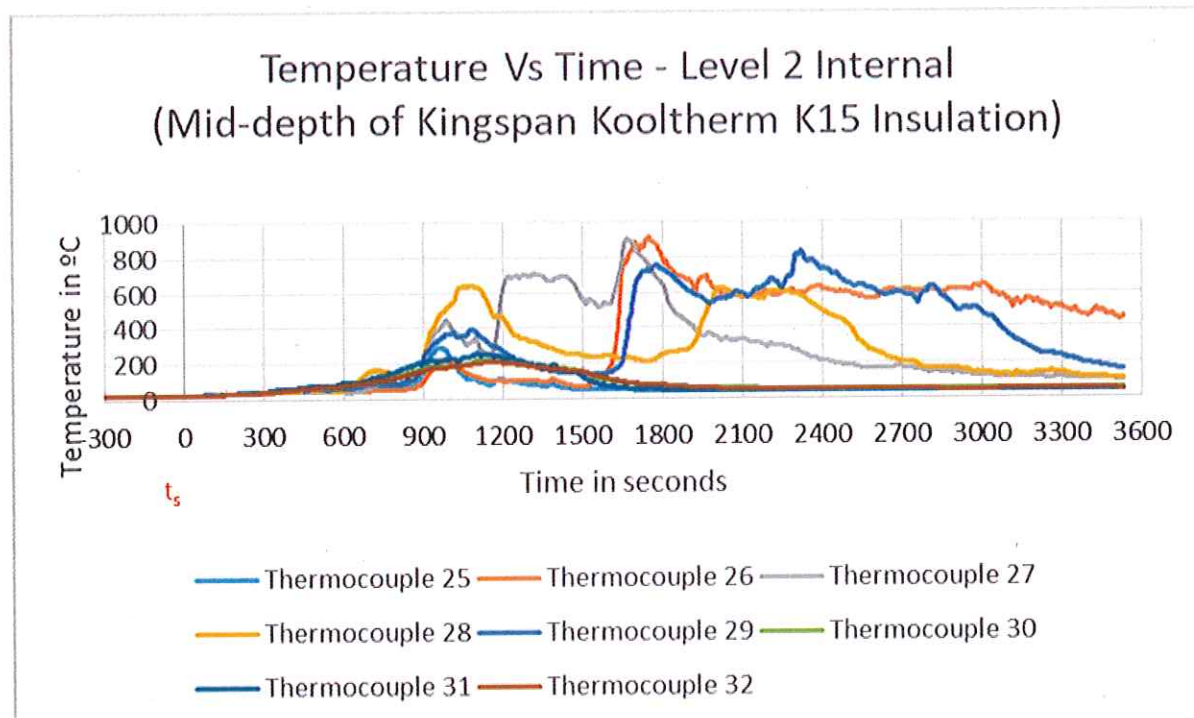

For thermocouple locations see Figure 3 & 4.

Figure 9 Thermocouple Readings on Level 2 – Internal (Mid-depth of 12mm Versapanel Cement Particle Board)

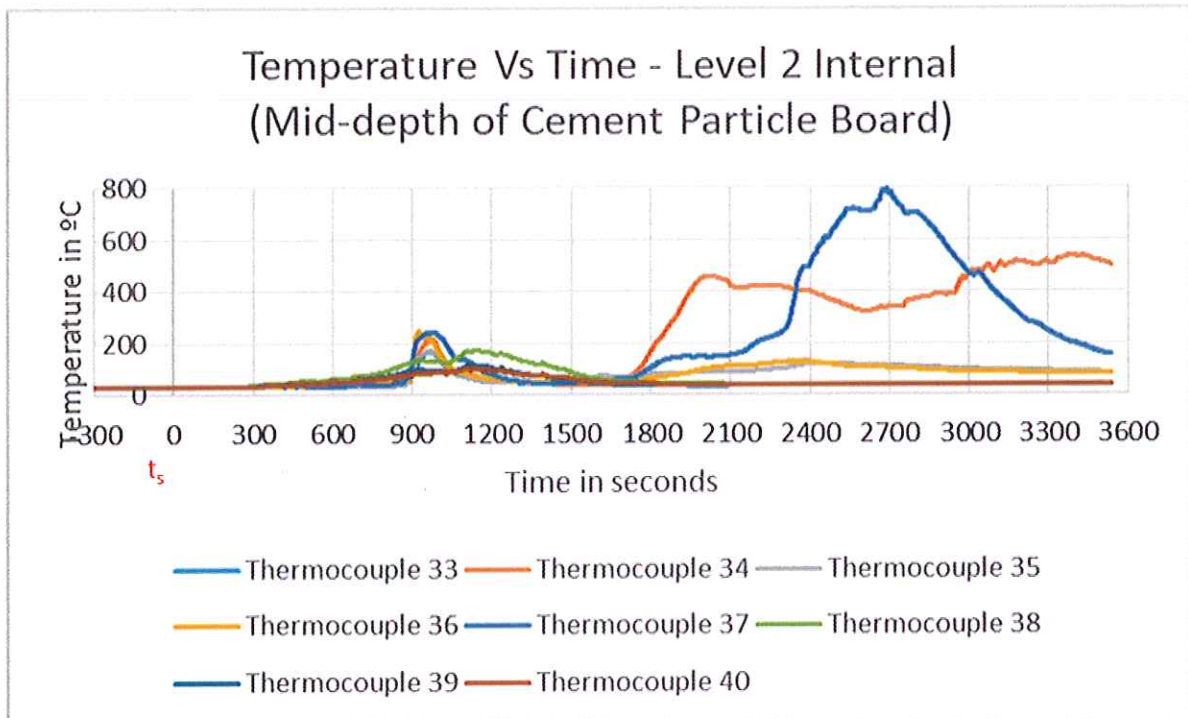

For thermocouple locations see Figure 3 & 4.

Figure 10 Thermocouple Readings on Level 2 – Internal (Mid-depth of 100mm Kingframe SFS)

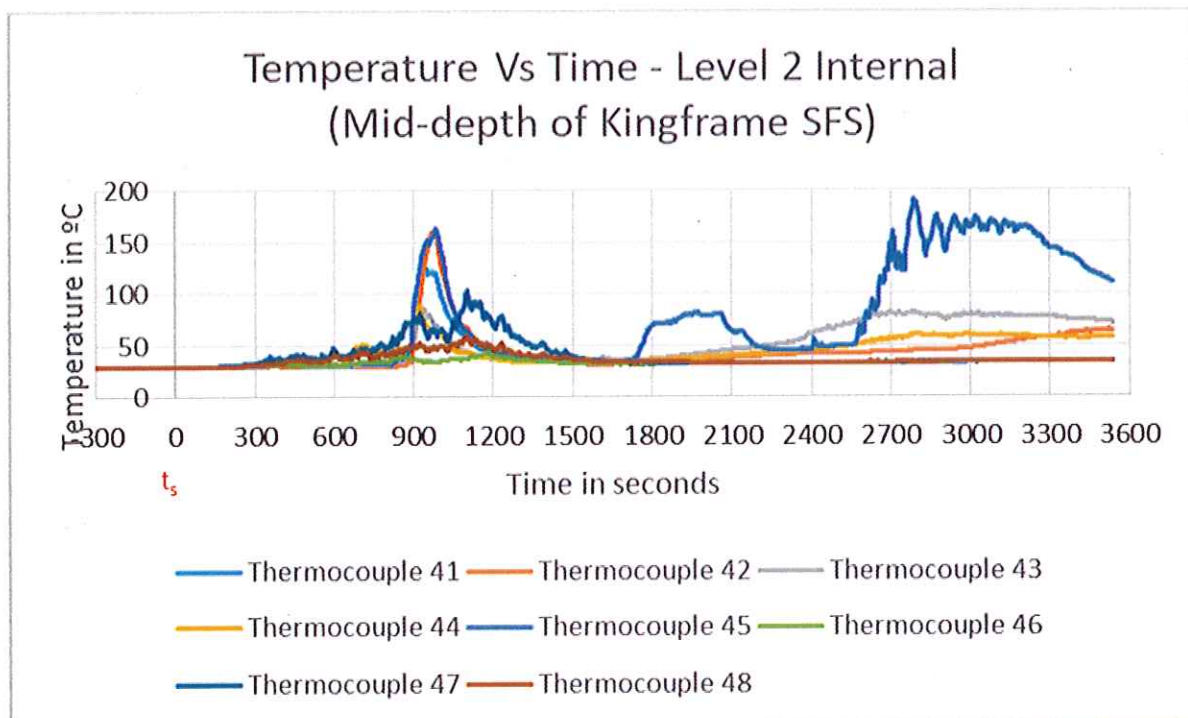

For thermocouple locations see Figure 3 & 4.

Figure 11 Thermocouple Readings on Level 2 – Internal (Mid-depth of 2 layers of 12.5mm Plaster Board)

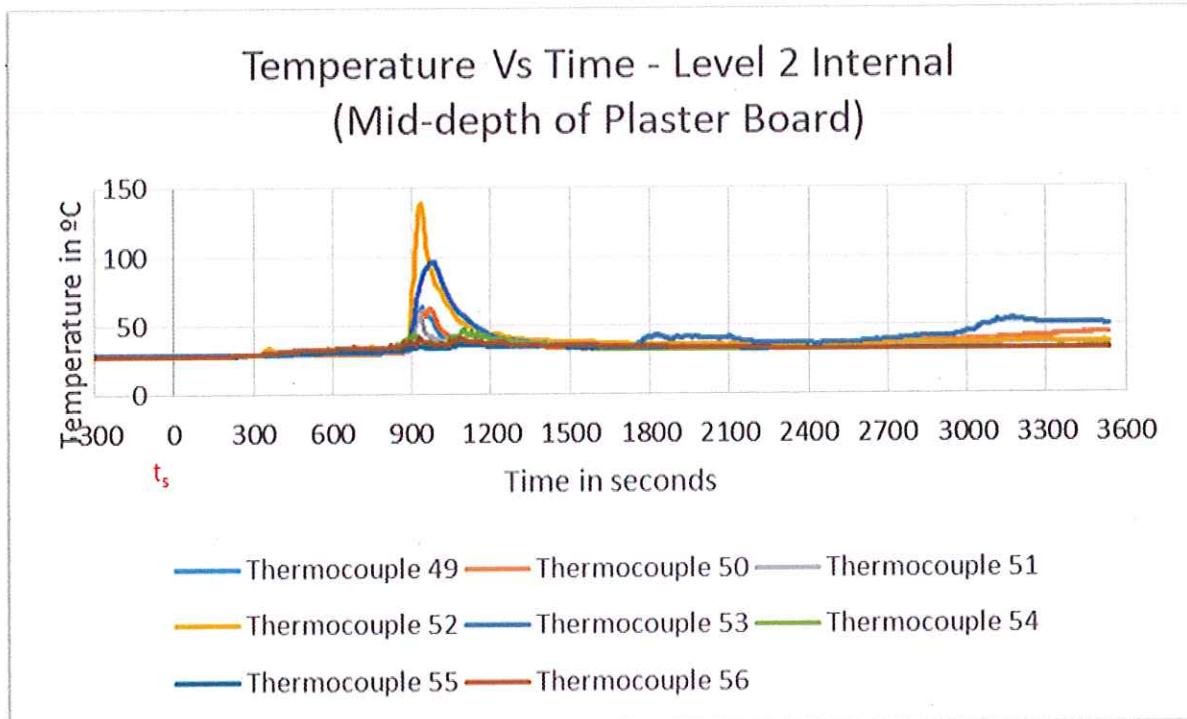

For thermocouple locations see Figure 3 & 4.

6.1 Post-test Examination

Table 4 below summarises the post-test observations.

Table 4 Post-test Observations

Sl. No.	Components	Observation	Photo Reference
1	2mm Aluminium Cassette panels	<p>Panels M1, M2, M4, M4, M12, M17, M22, M27 & M32 - No changes on the panels.</p> <p>Panels M3, M6, M11, M21, M29, M31, M34, M35 & M36 - 100% discoloration on the panels.</p> <p>Panels M5, M7, M28 & M33 - Minor discoloration on the panels.</p> <p>Panels M8, M11, M13, M16, M21 & M26 - Approximately 50% material loss observed. Remaining area was buckled and discoloured.</p> <p>Panels M9, M10, M14, M15, M19, M20, M25 & M30 - 100% material loss observed.</p> <p>Panels M18 & M23 - Approximately 50% of the panel was discoloured.</p> <p>Panels W1, W2, W3, W4, W5, W6, W7, W8, W9, W10, W11, W12, W13 & W14 - Panels were discoloured.</p> <p>Panels W15, W16, W17, W18, W19, W20, W21, W22, W23 & W24 - Minor discoloration on the panels.</p>	<p>DLP C2753J/0011.</p> <p>Please see Figure 13 in this section for damaged areas</p>
2.	Kingspan Kooltherm K15 insulation	<p>Main wall:</p> <p>Insulation behind panels M8, M9, M10, M13, M14, M15, M19, M20, M24 & M25 was completely burned and fell off.</p> <p>Insulation behind panels M11, M16, M18, M21, M23, M26, M28, M29, M30, M31, M33, M34, M35 & M36 was burned and left as char.</p> <p>Insulation behind panels M3, M6, M7 & M12 was discoloured.</p> <p>All other insulation on the main wall was in place and no changes observed.</p> <p>Wing wall:</p> <p>Insulation behind panels W7, W8, W9, W10, W11 & W12 was burned and left as char.</p> <p>All other insulation on the main wall was discoloured.</p> <p>Material loss observed.</p>	<p>DLP C2753J/0012, DLP C2753J/0016, & DLP C2753J/0017.</p>

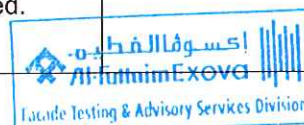

Sl. No.	Components	Observation	Photo Reference
3.	Cavity barrier	<p>Horizontal intumescent cavity barrier:</p> <p>Main wall:</p> <p>The 1st horizontal cavity barrier at 150mm above the combustion chamber was activated except the cavity barrier behind panel M7. Intumescent layer was not present during dismantling. Material loss observed.</p> <p>The 2nd horizontal cavity barrier at 2375mm above the combustion chamber was activated. Intumescent layer was partially present during dismantling. Cavity barrier was in place and material loss observed.</p> <p>The 3rd horizontal cavity barrier at 4875mm above the combustion chamber was activated except the cavity barrier behind panel M27. Intumescent layer was partially present during dismantling. Cavity barrier was in place and minor material loss observed.</p> <p>The 4th horizontal cavity barrier at 6890mm above the combustion chamber was activated except the cavity barrier behind panel M32. Intumescent layer was present during dismantling. Cavity barrier was in place and minor material loss observed.</p> <p>Wing wall:</p> <p>All the cavity barriers on the wing wall were activated. Intumescent layer was present during dismantling. Minor material loss observed.</p> <p>Vertical cavity barrier:</p> <p>Buckling and discoloration on the vertical cavity barrier on the main wall and wing wall.</p>	DLP C2753J/0012, DLP C2753J/0015, DLP C2753J/0016 & DLP C2753J/0017.
4.	Railings	<p>Railings:</p> <p>Railings behind panels M8, M9, M10, M11, M13, M14, M15 M16, M18, M19, M20, M21, M23, M24, M25 & M26 were melted completely.</p> <p>Railings behind panels M28, M29, M30, M31, M33, M34, M35 & M36 were discoloured and buckled.</p> <p>All other railings on the main wall were in place and no damage was observed.</p> <p>All the railings on the wing wall were discoloured.</p>	DLP C2753J/0012, DLP C2753J/0016 & DLP C2753J/0017.

Sl. No.	Components	Observation	Photo Reference
5.	Brackets and Breather membrane	<p>Brackets:</p> <p>Approximately 10% of the Helping Hand brackets on the main wall were partially melted.</p> <p>All other brackets on the main wall and wing wall were in place and no damage was observed.</p> <p>Breather membrane:</p> <p>Material loss and discolouration to the Nilvent breathable membrane on the main wall and wing wall.</p>	DLP C2753J/0013, & DLP C2753J/0018.
6.	12mm Versapanel cement particle board	Minor damages and discolouration to the Versapanel cement particle board on the main wall and no significant changes to the Versapanel cement particle board on wing wall.	DLP C2753J/0013, & DLP C2753E/0018.
7.	Kingframe SFS and plaster boards	No significant changes.	DLP C2753J/0014.

Figure 12 Area Map Showing the Condition of the Sample After the Test

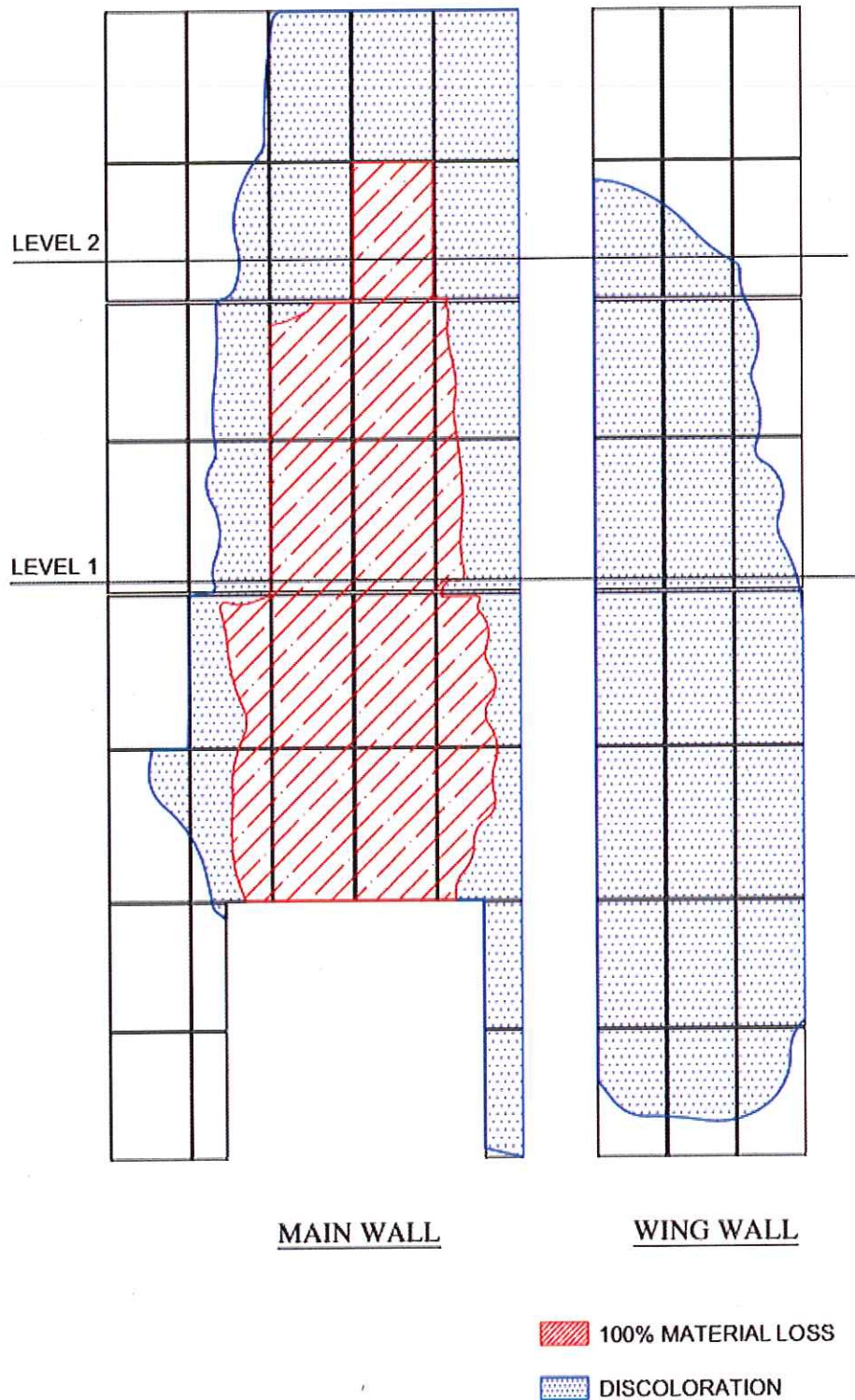

- Approximately 9m² of the total external visible area was completely consumed.
- Approximately 19m² of the total external visible area was discoloured.

Appendix A

Photographs

Note: Any warp in the images is due to fish eye effect of the camera.

Pre-test Phase



DLP C2753J/2383 100mm Kingframe SFS and plaster board

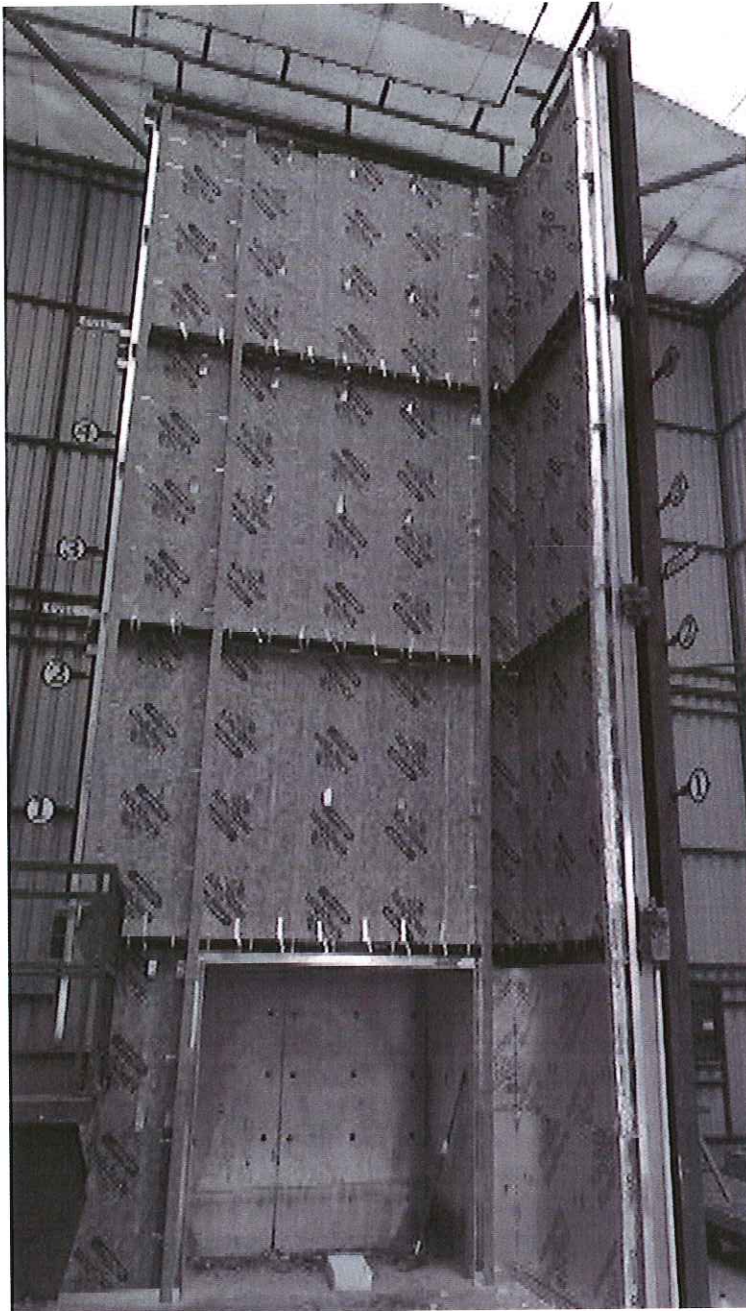

DLP C2753J/3180 Nilvent breather membrane, cavity barriers and aluminium support bracket

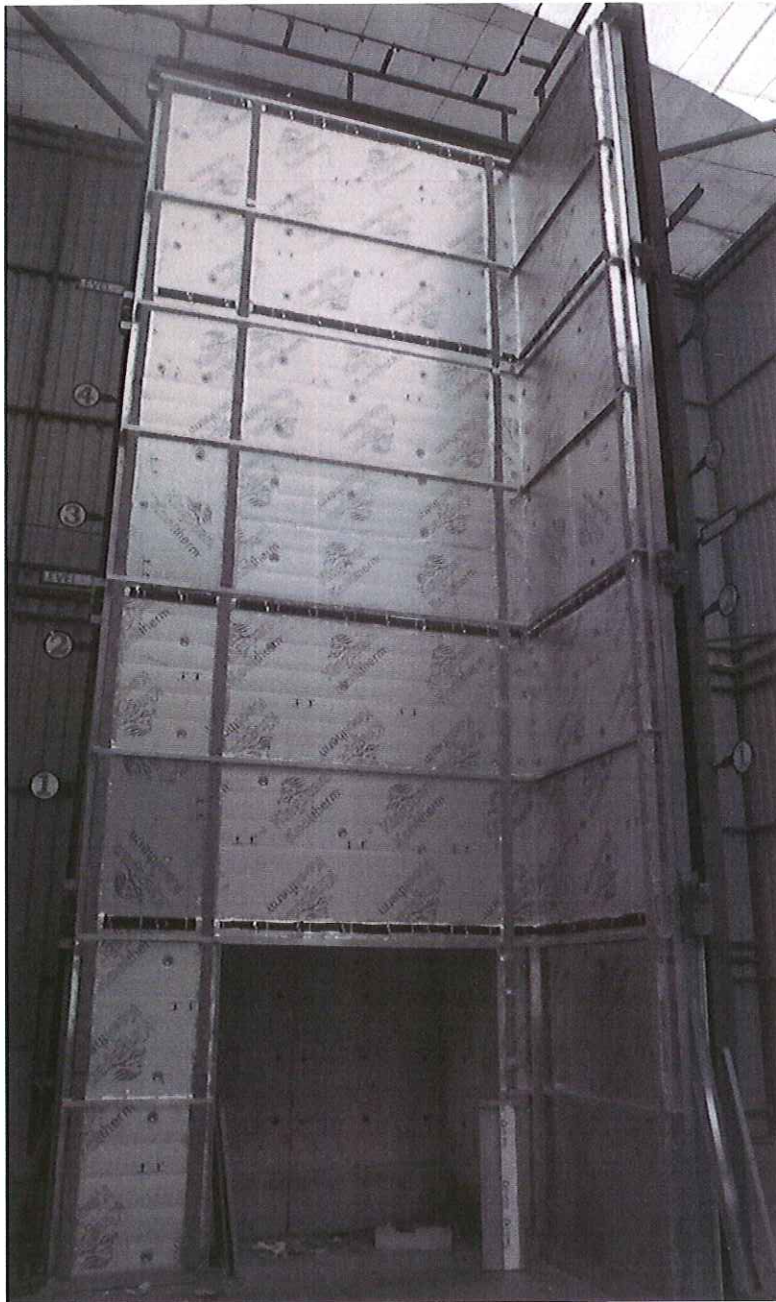

DLP C2753J/2685 Kingspan Kooltherm K15 insulation and horizontal railings

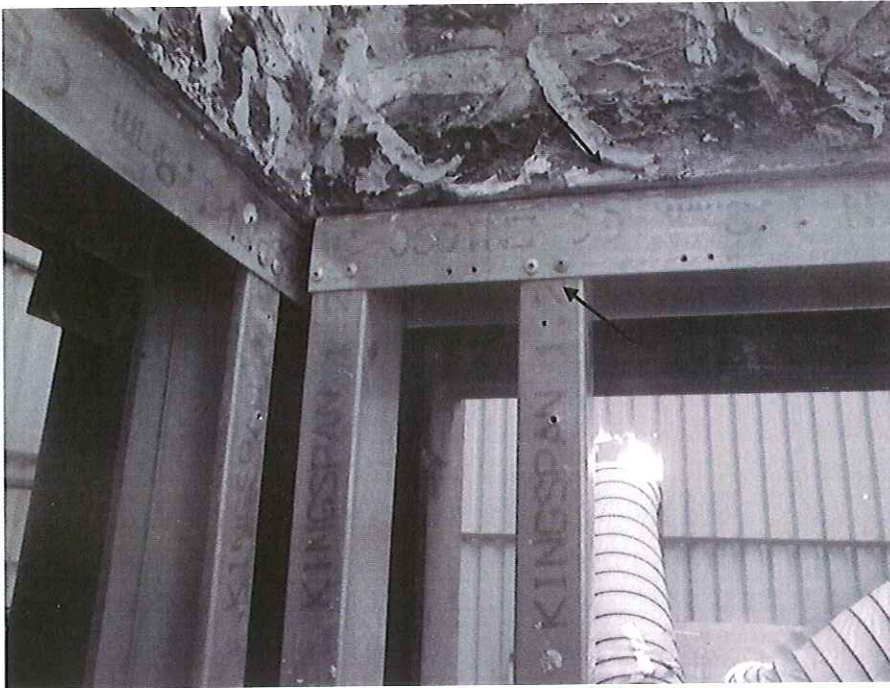

DLP C2753J/2384 Kingframe SFS fixing

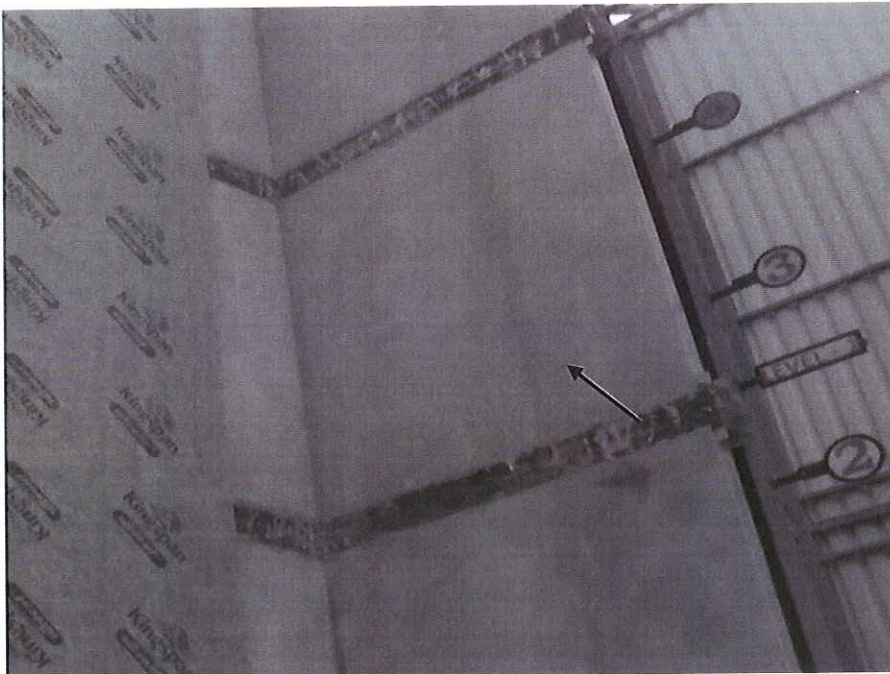

DLP C2753J/2583 12mm Versapanel cement particle board

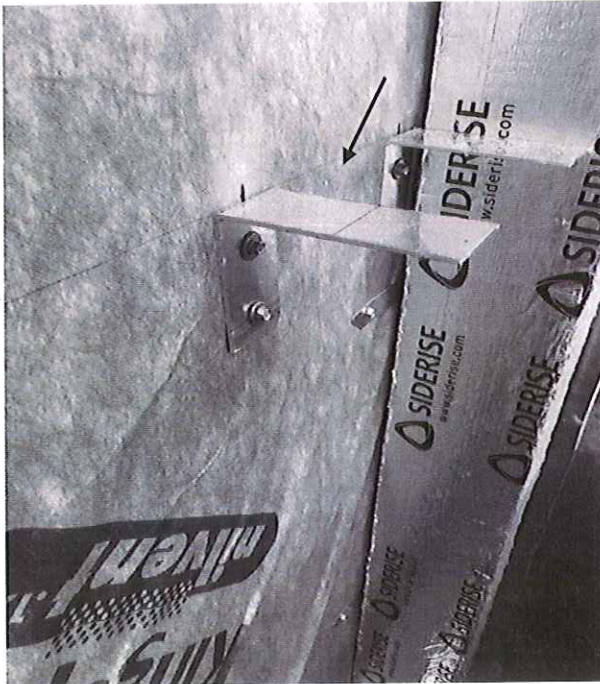

DLP C2753J/3173 Aluminium support bracket

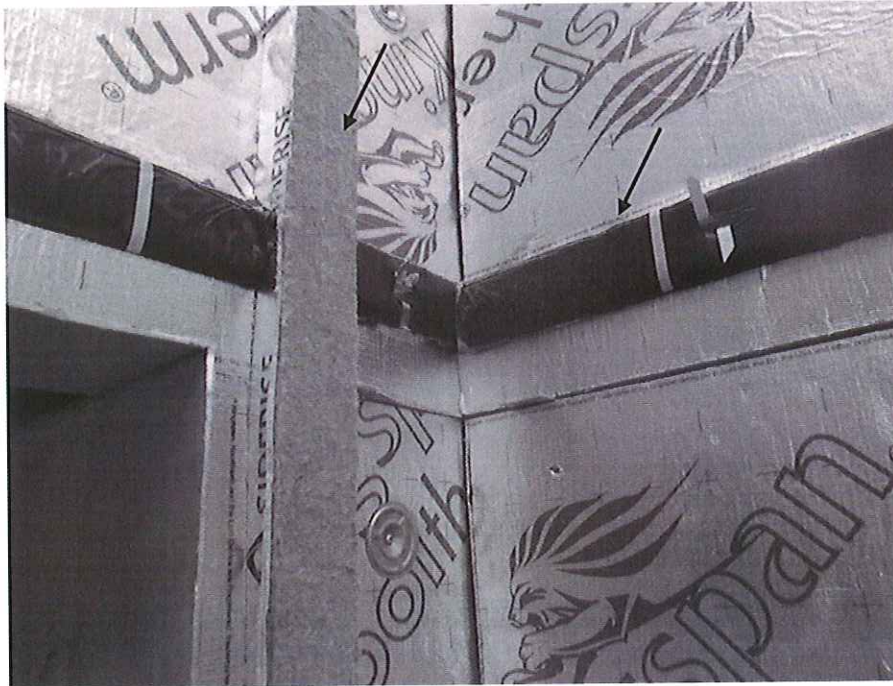

DLP C2753J/2661 Horizontal intumescent and vertical cavity barrier

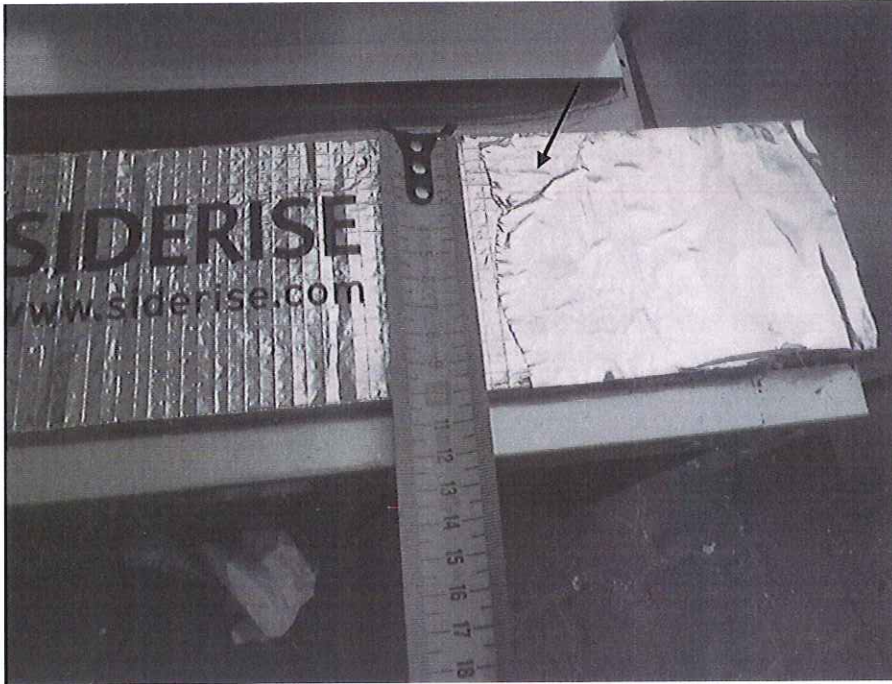

DLP C2753J/2674 Siderise open state cassette insert (OSCI)

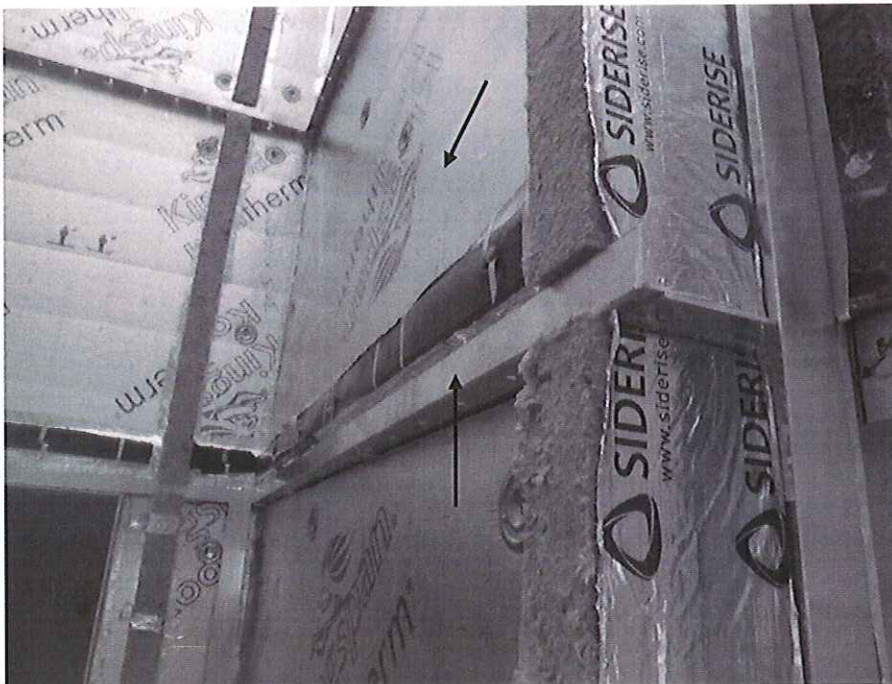

DLP C2753J/2690 Insulation and horizontal railings



DLP C2753J/2733 Aluminium window pod around the combustion chamber

Testing Phase

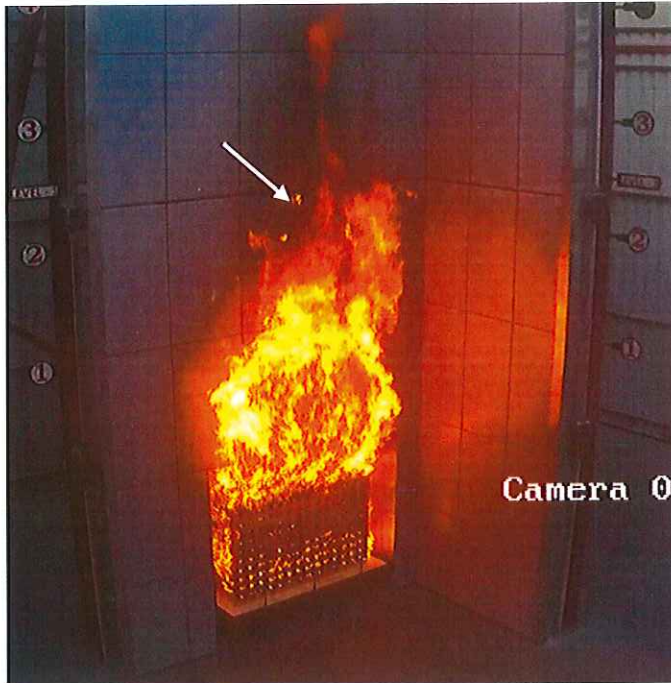

DLP C2753J/0001 Coating of panels M19 & M20 started to burn off.



DLP C2753J/0002 Panels M9, M10, M14 & M15 partially melted and insulation behind the panels burning.



DLP C2753J/0003 Self-sustained flames on the surface of panel W7.

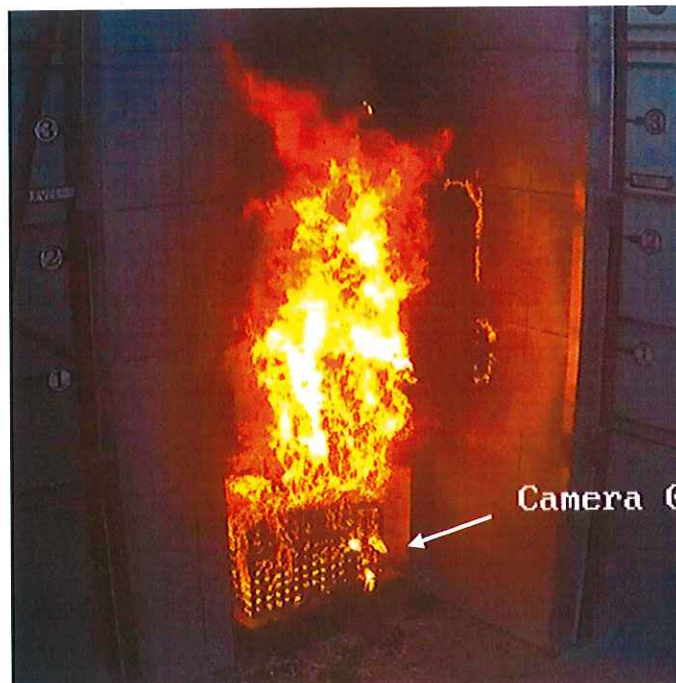

DLP C2753J/0004 Flaming debris fell off the main wall.



DLP C2753J/0005 Approximately 90% of panels M9, M10, M14 & M15 melted.

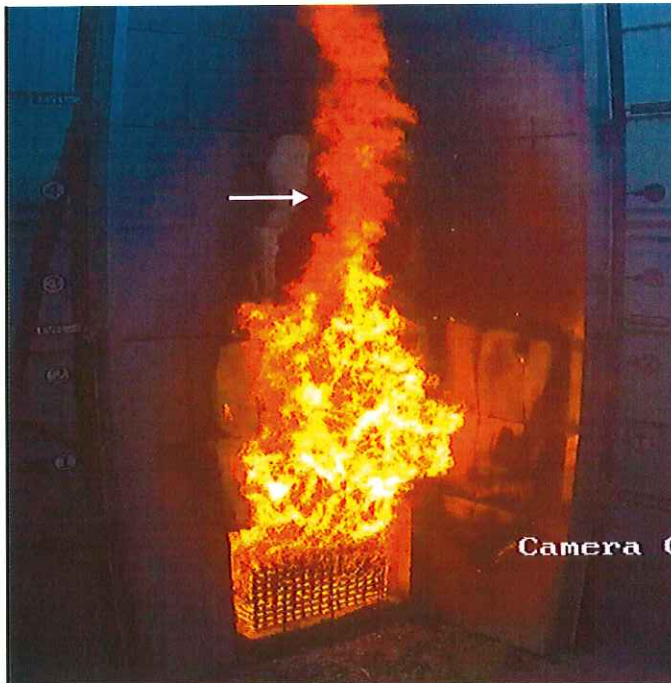

DLP C2753J/0006 Panels M24 & M25 partially melted and insulation behind the panels burning.

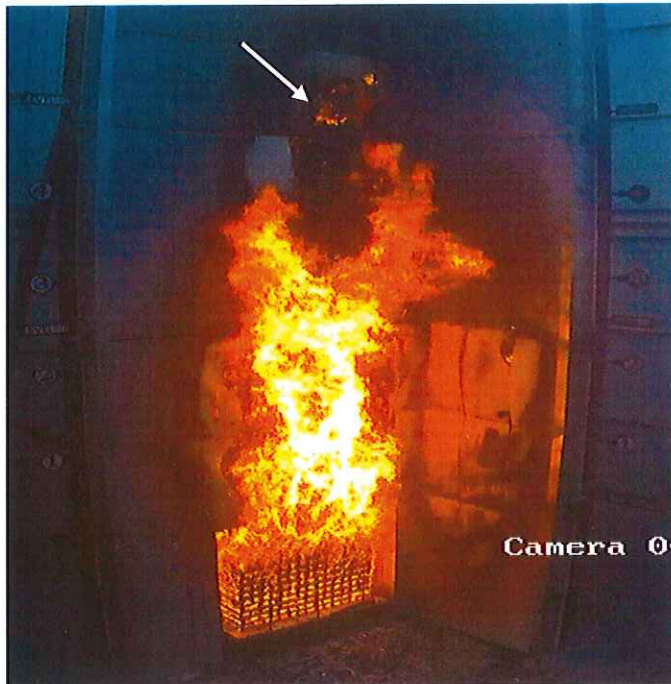

DLP C2753J/0007 High intensity flames on the insulation behind panel M30.



DLP C2753J/0008 100% of the panels M19, M20, M25 & M30 consumed fell off.

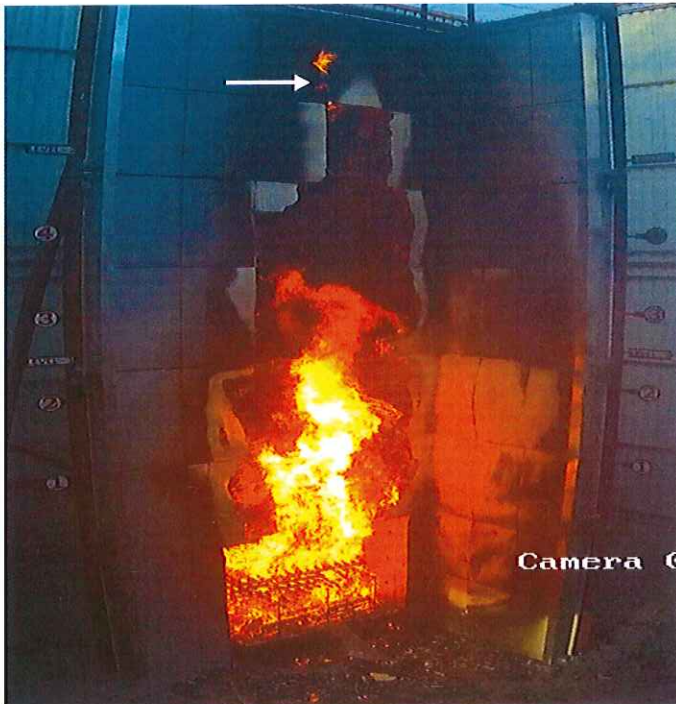

DLP C2753J/0009 Flames behind panel M35.



DLP C2753J/0010 Flaming debris of the insulation behind panel M24.

Post-Test Phase



DLP C2753J/0011

View of the sample after the test



DLP C2753J/0012

Kingspan Kooltherm K15 insulation, cavity barrier and railings



DLP C2753J/0013

Breather membrane and brackets



DLP C2753J/0014

Kingframe SFS and plaster board



DLP C2753J/0015 Cavity barrier above the combustion chamber



DLP C2753J/0016 Vertical cavity barrier, insulation and railings on main wall



DLP C2753J/0017 Cavity barrier, insulation and railings on wing wall



DLP C2753J/0018 Brackets and cement particle board

Appendix B

Drawings

The following nineteen un-paginated sheets are copies of Kingspan Insulation Ltd. drawings numbered:

- K15 + Dri-Design DLR1547-1 Rev. 2
- K15 + Dri-Design DLR1547-2 Rev. 2
- K15 + Dri-Design DLR1547-3 Rev. 2
- K15 + Dri-Design DLR1547-4 Rev. 2
- K15 + Dri-Design DLR1547-5 Rev. 2
- K15 + Dri-Design DLR1547-6 Rev. 2
- K15 + Dri-Design DLR1547-7 Rev. 2
- K15 + Dri-Design DLR1547-8 Rev. 2
- K15 + Dri-Design DLR1547-9 Rev. 2
- K15 + Dri-Design DLR1547-10 Rev. 2
- K15 + Dri-Design DLR1547-11 Rev. 2
- K15 + Dri-Design DLR1547-12 Rev. 2
- K15 + Dri-Design DLR1547-13 Rev. 2
- K15 + Dri-Design DLR1547-14 Rev. 2
- K15 + Dri-Design DLR1547-15 Rev. 2
- K15 + Dri-Design DLR1547-16 Rev. 2
- K15 + Dri-Design DLR1547-17 Rev. 2
- K15 + Dri-Design DLR1547-18 Rev. 2
- K15 + Dri-Design DLR1547-19 Rev. 2

Name:

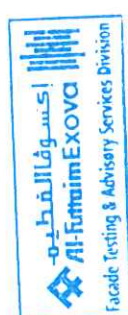
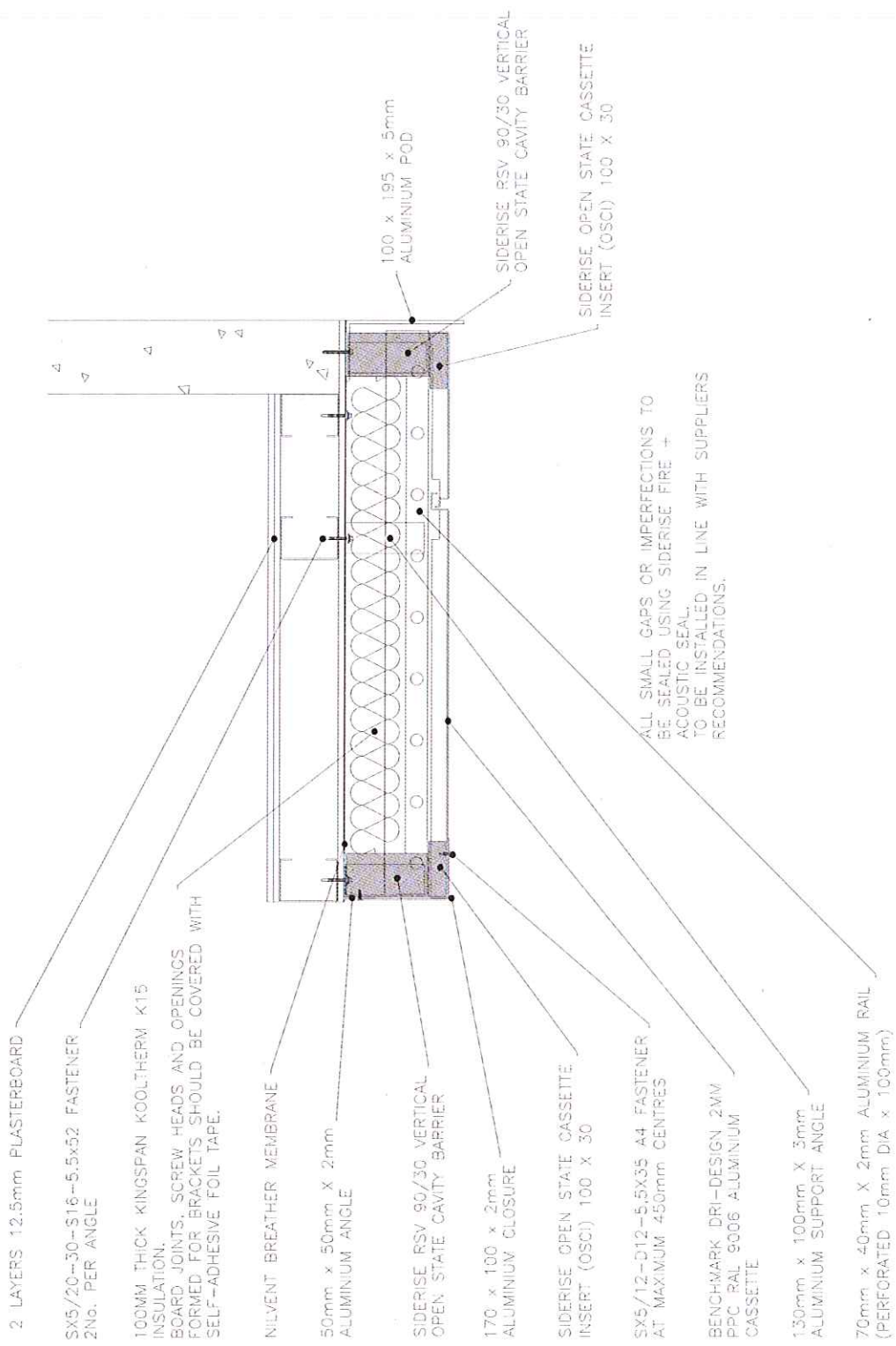

Rev	Description	Drawn	Date



Kingspan Limited
Greenfield Business Park No. 2, Greenfield,
Holywell, Flintshire, CH8 7GJ, UK
Tel: 0800 597 0090
www.kingspan.co.uk

Camdenrose Road, Inverclyde
www.kingspan.co.uk
Tel: 0800 42 96 0820

Client: Kingspan

Project: BS8414 fire Test
Kingspan K18+Dri-Design

Grouping: Horizontal Details

Drawn By	Checked By	Date
ALC		08/08/10
Drawing Number	Revision	
K18 - Dri-Design DURT1547-1	2	

This drawing is the property of Kingspan and is not to be used for any other project without the written consent of Kingspan.

Notes:

No.	Description	Chg.	Date



Kingspan Limited
Greenfield Business Park, No. 2, Greenfield,
Carrigrohane, Co. Cork, Ireland
www.kingspanpanels.co.uk
T: 0800 517 0000

Carraigrohane Road,
Kingscourt, Co. Cork, Ireland
www.kingspanpanels.ie
T: 00353 47 90 8620

Client
Kingspan

Project
BS8414 fire Test
Kingspan K15+Dri-Design

Drawn by
Horizontal Details

Status:

Drawn by	Checked by	Date
AE		00/00/10

Drawn's Number	Revision
K15 - Dri-Design DLR147-2	2

This drawing is the property of Kingspan and shall remain confidential to Kingspan.

SIDERISE RSV 90/30 VERTICAL
OPEN STATE CAVITY BARRIER

100 x 195 x 5mm
ALUMINIUM POD

SIDERISE OPEN STATE CASSETTE
INSERT (OSCI) 100 x 30

50 x 75 x 2mm
ALUMINIUM CLOSURE

130mm x 100mm X 3mm
ALUMINIUM SUPPORT ANGLE

BENCHMARK DRI-DESIGN 2MM
PPC RAL 9006 ALUMINIUM
CASSETTE

70mm x 40mm X 2mm
ALUMINIUM RAIL (PERFORATED
10mm DIA x 100mm)

SX5/12-D12-5,5X35 A4 FASTENER
AT MAXIMUM 450mm CENTRES

SIDERISE OPEN STATE CASSETTE
INSERT (OSCI) 100 x 30

170 x 100 x 2mm
ALUMINIUM CLOSURE

SIDERISE RSV 90/30 VERTICAL
OPEN STATE CAVITY BARRIER

100MM THICK KINGSPAN KOOLTHERM K15
INSULATION. BOARD JOINTS, SCREW HEADS AND OPENINGS
FORMED FOR BRACKETS SHOULD BE COVERED
WITH SELF-ADHESIVE FOIL TAPE.

2 LAYERS 12.5mm PLASTERBOARD

NILVENT BREATHER MEMBRANE

SX5/20-30-S16-5,5X52 FASTENER
2No. PER ANGLE

50mm x 50mm X 2mm
ALUMINIUM ANGLE

SX5/12-D12-5,5X35 A4 FASTENER
AT MAXIMUM 450mm CENTRES

ALL SMALL GAPS OR IMPERFECTIONS TO
BE SEALED USING SIDERISE FIRE +
ACOUSTIC SEAL.
TO BE INSTALLED IN LINE WITH SUPPLIERS
RECOMMENDATIONS.

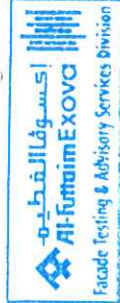

Notes:

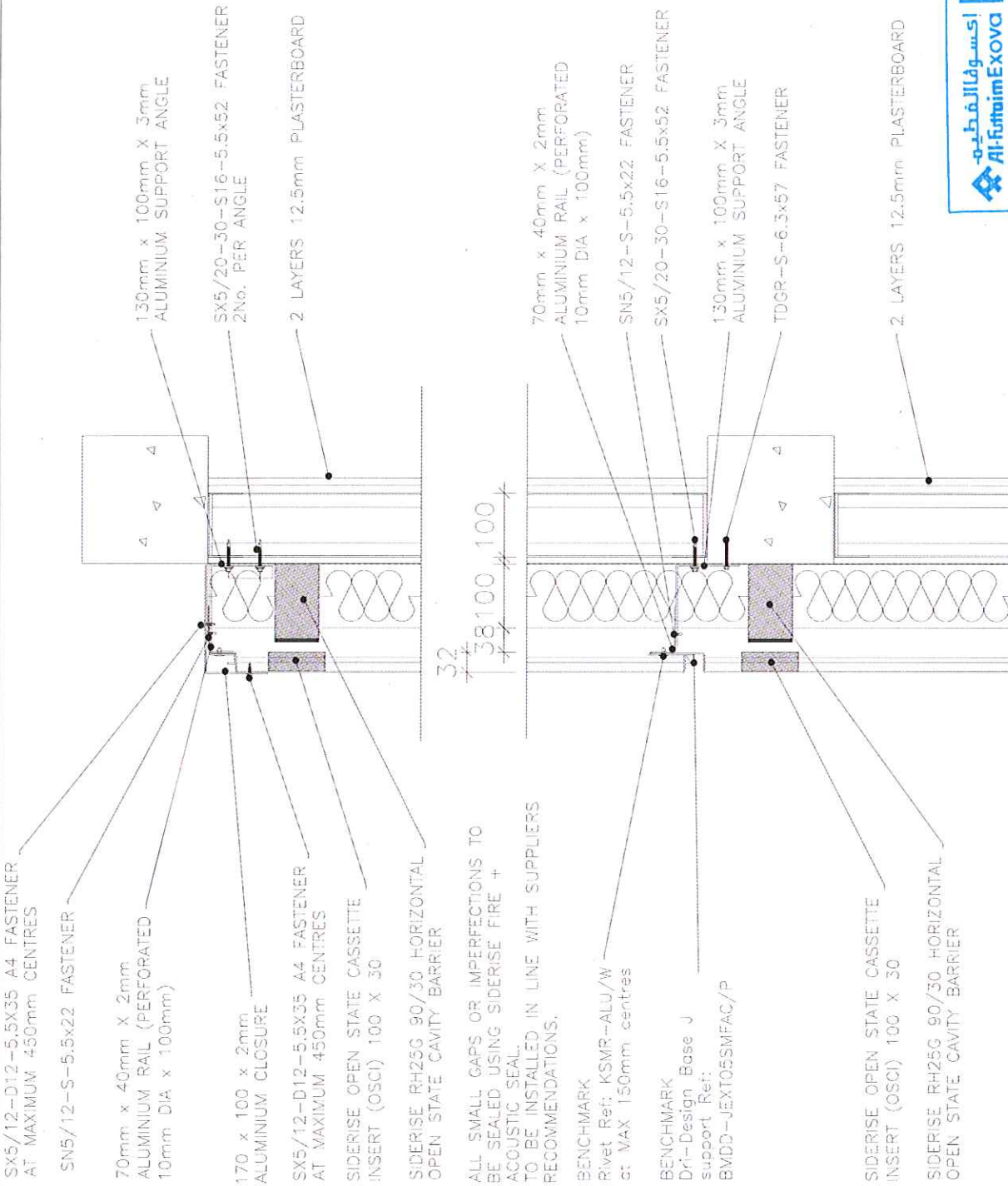

Kingspan Limited
 Greenfield Business Park No. 2, Greenfield,
 Holywell, Flintshire, CH8 7ZJ, UK
 Tel: 0800 387 0090

Kingspan (Ireland) Ltd
 Kingspan Park, Carrigrohane, Co. Cork, Ireland
 www.kingspanpanels.ie
 Tel: 0800 42 96 9020

Client: Kingspan

Project:
 BSS414 fire Test
 Kingspan K18+Dri-Design

Drawing:
 Vertical Details

Scale:

Drawn By	Checked By	Date
AC		06/06/10

Drawing Number	Revision
K18 - Dri-Design DB1847-3	2



This drawing is the property of Kingspan and is not to be reproduced, stored in a retrieval system or transmitted in any form or by any means, electronic, mechanical, photocopying, recording or otherwise, without prior permission.

Notes:

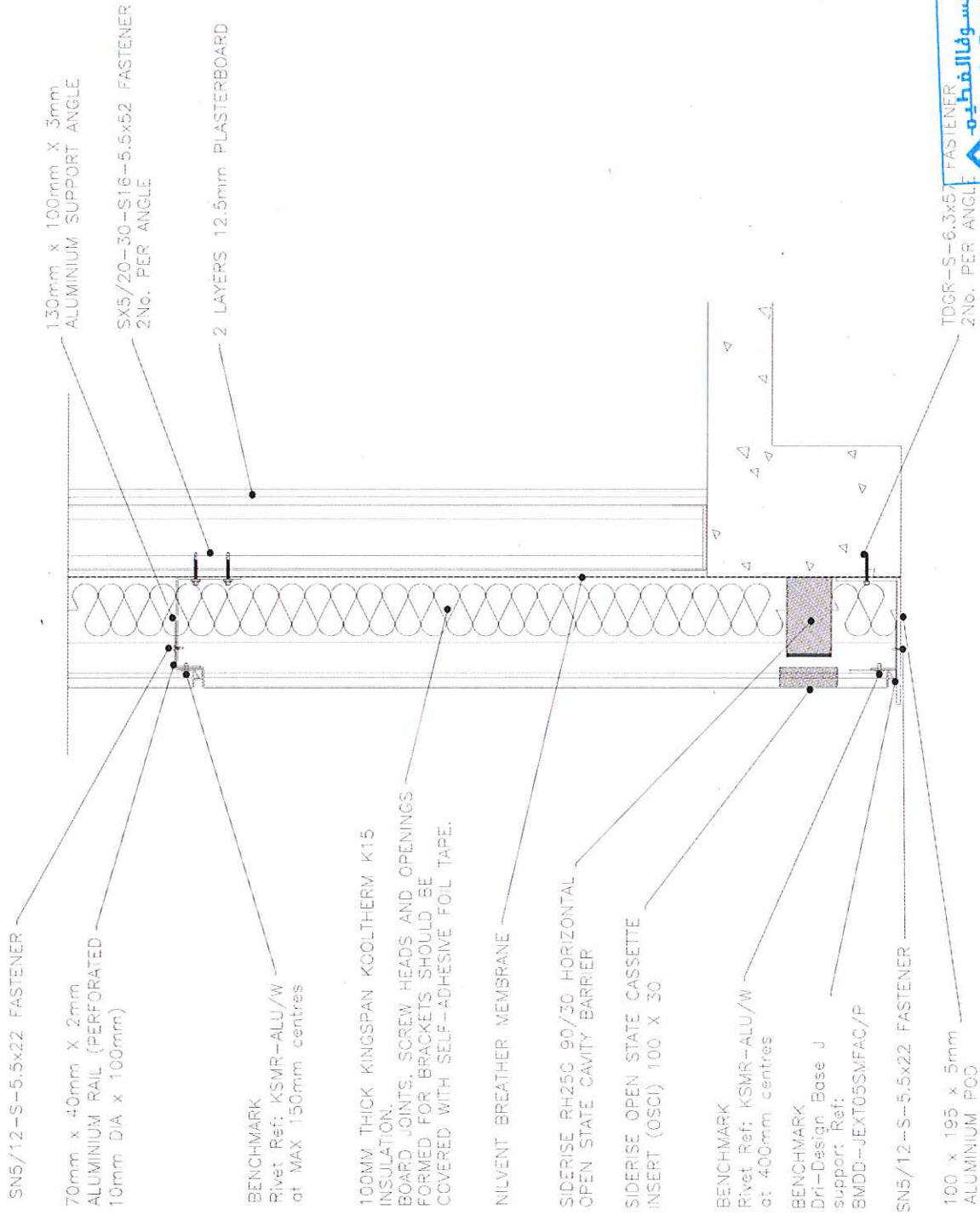

Kingspan Limited
Greenfield Business Park No. 2, Greenfield,
Holywell, Flintshire, CH8 7GJ, UK
www.kingspan.co.uk
T: 0800 307 0090

Candamara Road,
Candamara, Ireland
www.kingspan.ie
T: 00353 42 96 9520

Client
Kingspan

Project
BS8414 fire Test
Kingspan K15-Dri-Design

Category
Vertical Details

Status

Drawn By	Checked By	Date
AL	08/08/10	
Drawing Number	Revision	
05 - Dri-Design DLR197-4	2	

كسب و القاب Exova
Facade Testing & Advisory Services Division

This drawing is the property of Kingspan and
is not to be used, copied, reproduced or
distributed without Kingspan's written
consent.

Notes:

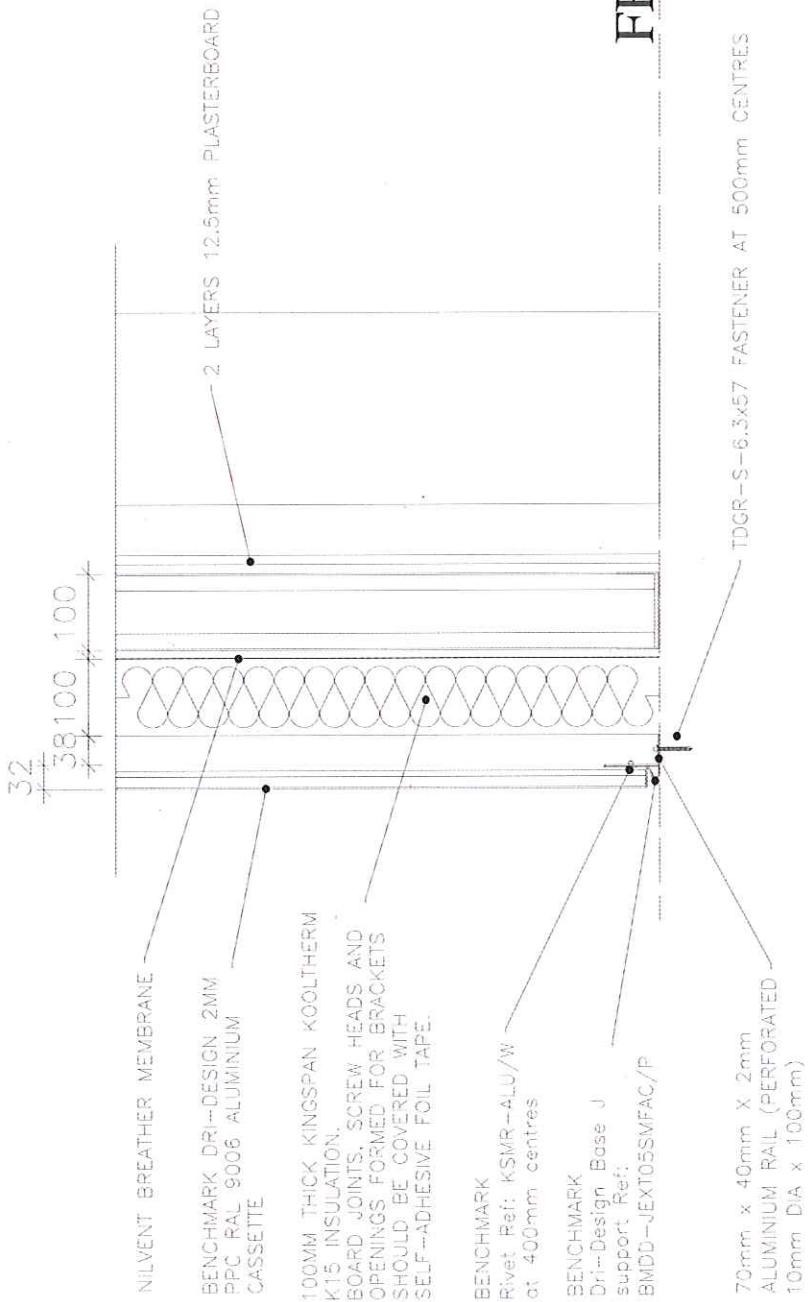

No	Description	Chkd	Date



Kingspan Limited
Greenfield Business Park No. 2, Greenfield,
Kesh, Co. Wick, Ireland
www.kingspaninsulation.co.uk
T: 00353 547 0090

Carrollmore Road
Kingscourt, Co. Carlow, Ireland
www.kingspanpanels.ie
T: 00353 42 98 9929

Client
Kingspan

Project
BS8414 fire Test
Kingspan K15+Dri-Design

Drawing
Vertical Details

Scale

Drawn by	Checked by	Date
AE		09/06/19
Drawing Number	Revision	
K15 - Dri-Design DR1547.5	2	

This drawing is the property of Kingspan and
written consent from Kingspan



Notes:

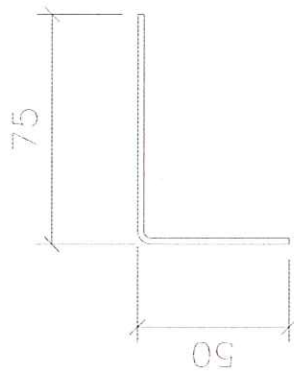

3000mm LONG

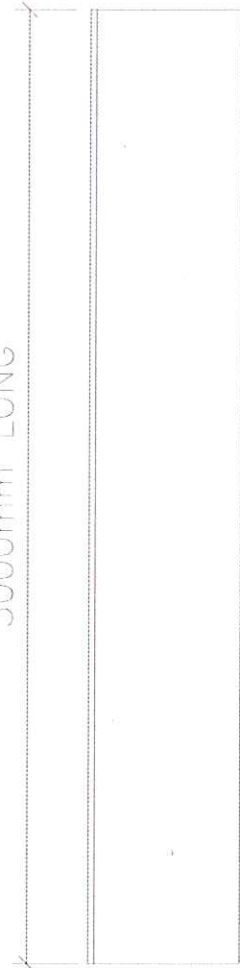

Kingspan Limited
 Greenfield Business Park No. 2, Greenfield,
 Holywell, Flintshire, CH8 7GJ, UK
 Tel: 01890 597 0000
 www.kingspan.co.uk

Cardinal Point Road, Millfield
 Kingspan Building, Millfield
 www.kingspanpanels.ie
 T: 00353 42 96 91029

Client
Kingspan

Project
**BSS414 fire Test
 Kingspan K15+Dr-Design**

Category
Aluminium Closure

Drawn By

Checked By

Date
 08/08/13

Drawn No.
 AC

Drawn Number
 K15 - Dr-Design DLE1547-2

Revision
 2

This drawing is the property of Kingspan and
 shall remain confidential. It is not to be
 used or copied without the written
 authority of Kingspan.

MATERIAL: 2mm ALUMINIUM GRADE 3103 H14 OR 5251 H22
 FINISH: MILL

QUANTITY: 5No.



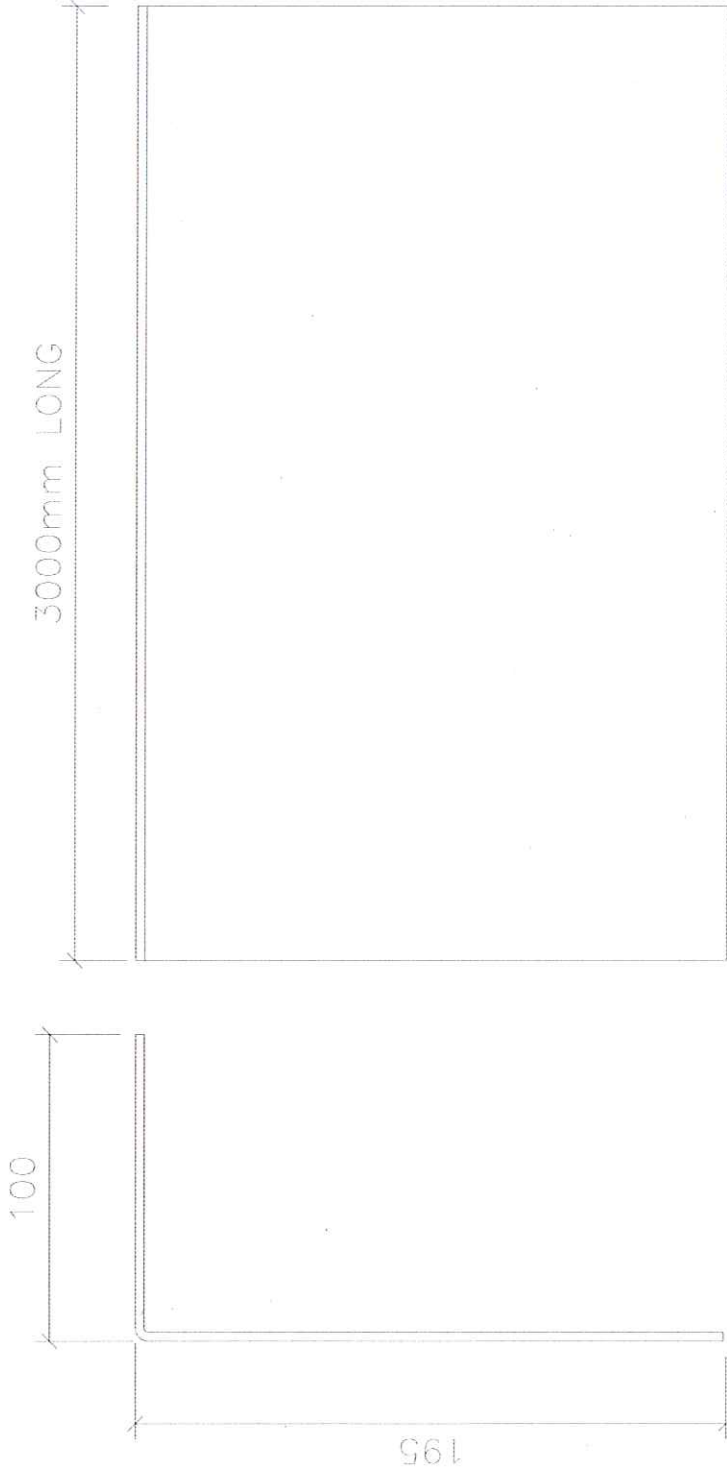

MATERIAL: 3mm ALUMINIUM GRADE 3103 H14 OR 5251 H22
 FINISH: MILL

QUANTITY: 5No.



Notes:

Rev	Description	Chd	Date



Kingspan Limited
 Greenfield Business Park No. 2, Greenfield,
 Carrigrohane, Co. Cork, Ireland
 www.kingspaninsulation.co.uk
 T: 0800 347 0090

Central Business Road,
 Kingspan, Co. Cork, Ireland
 www.kingspaninsulation.ie
 T: 02023 42 36 3020

Client:
 Kingspan

Project:
 BS8414 fire Test
 Kingspan K15+Dr-Design

Drawn:
 Aluminium Closure

Scale:

Drawn by	Checked by	Date
AE		00/00/10

Drawing Number	Revision
K15 + Dr-Design DLT-1547-7	2

This drawing is the property of Kingspan and
 shall remain confidential to Kingspan

Notes:

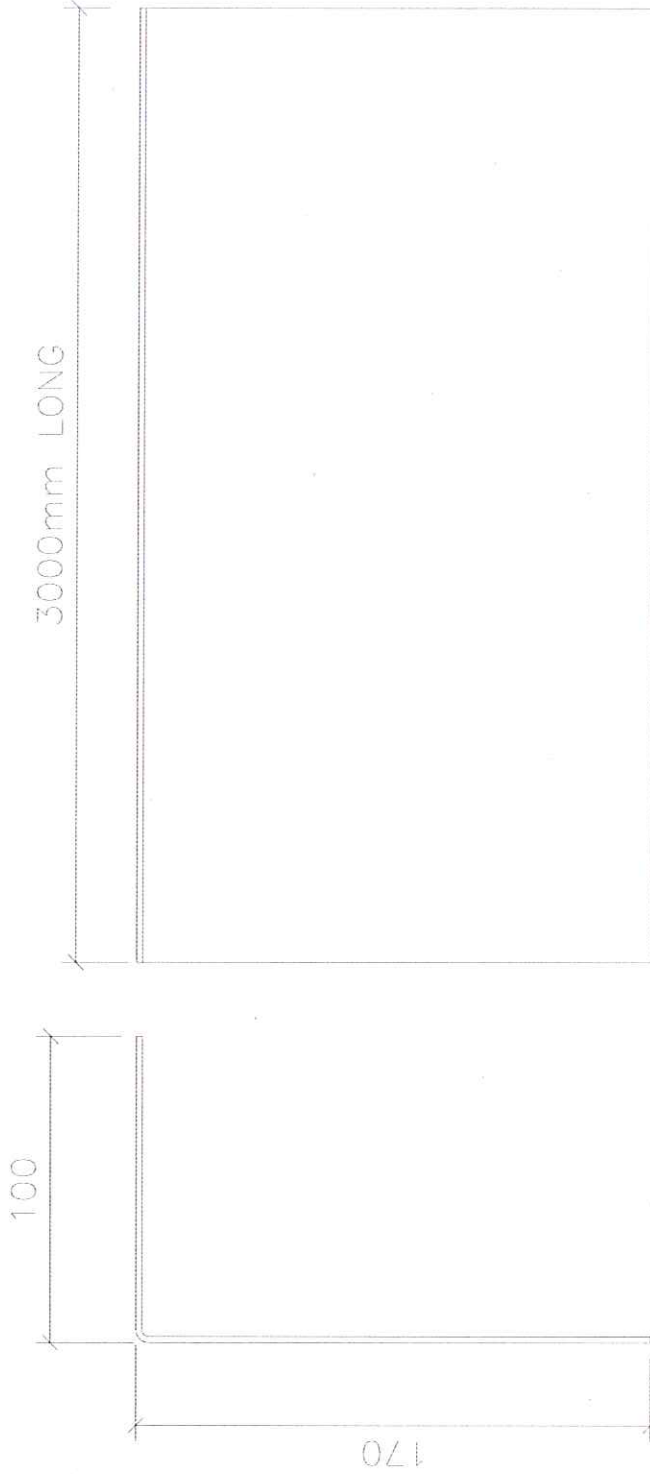

MATERIAL: 2mm ALUMINIUM GRADE 3103 H14 OR 5251 H22
 FINISH: MILL

QUANTITY: 10No.



No.	Description	QTY	Date



Kingspan Limited
 Greenfield Business Park, No. 2, Greenfield,
 Maynooth, Co. Wick, Ireland
 Tel: +353 (0)1 850 347 0000

Customer Service, Stock,
 Kingspan, Co. Louth, Ireland
 www.kingspanpanels.ie
 E: 00353 42 96 98209

Client

Kingspan

Project

BSS8414 fire Test
 Kingspan K15+Di-Design

Quantity

Aluminium Closure

Status

Drawn By	Checked by	Date
AE		06/09/10

Drawing Number	Revision
K15 - Di-Design DLT1547-3	2

This drawing is the property of Kingspan and
 must be returned to Kingspan

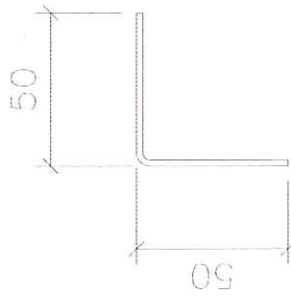

3000mm LONG

Rev	Description	Chgd	Date



Kingspan Limited
Greenfield Business Park, No. 2, Greenfield,
Carrickmacross, Co. Du., UK
www.kingspanpanels.co.uk
T: 0800 357 0990

Carrickmacross Road,
Kingscourt, Co. Carrig, Ireland
www.kingspanpanels.ie
T: 00353 47 96 91529

Client
Kingspan

Product
BS8414 fire Test
Kingspan K15+Dr+Design

Drawings
Aluminium Angle

Station

Drawn by	Checked by	Date
AE		09/09/13

Drawing Number	Revision
K15 - Dr+Design DLT15029	2

This drawing is the property of Kingspan and
written consent from Kingspan

MATERIAL: 2mm ALUMINIUM GRADE 3103 H14 OR 5251·H22
FINISH: MILL

QUANTITY: 10No.



Name:

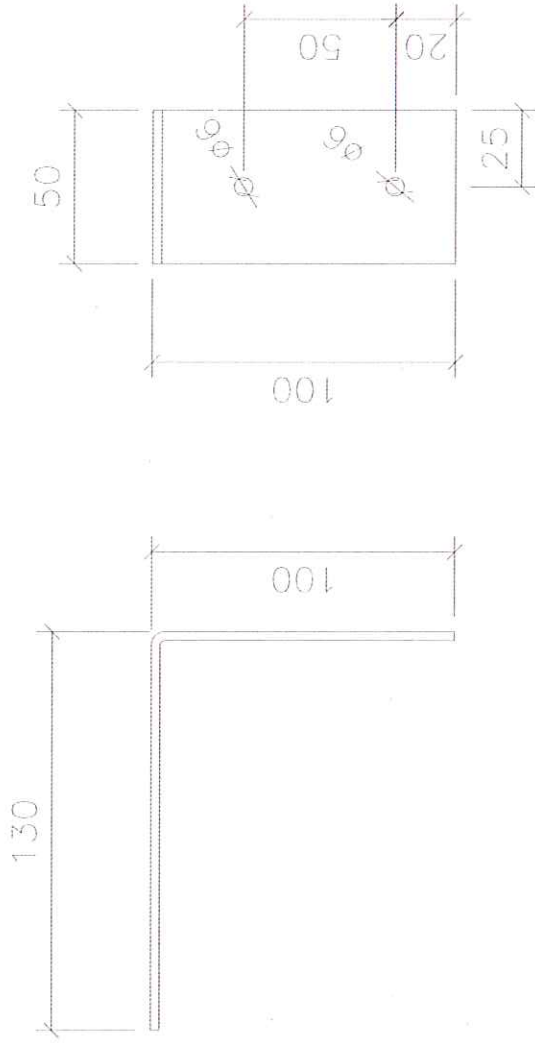

MATERIAL: 3mm ALUMINIUM GRADE 3103 H14 OR 5251 H22
 FINISH: MILL

QUANTITY: 90No.



Rev	Description	Chgd	Date



Kingspan Limited
 Greenfield Business Park, No. 2, Greenfield,
 Holywell, Flintshire, CH8 7GJ, UK
 Tel: 0800 597 0090
 Email: enquiries@kingspan.co.uk

Condamaroon Road,
 Condamaroon, Co. Wick, Ireland
www.kingspanpanels.ie
 Tel: 00353 42 96 88529

Client:

Kingspan

Project:

BS8414 fire Test
 Kingspan K18+Dr-Design

Company:

Aluminium Support

Station:

Drawn by:	Checked by:	Date:
AC		08/06/10

Drawing Number	Revision
K18 + Dr-Design DLR1547-10	2

This drawing is the property of Kingspan and is not to be reproduced or used in any way without the written consent of Kingspan.

Notes:

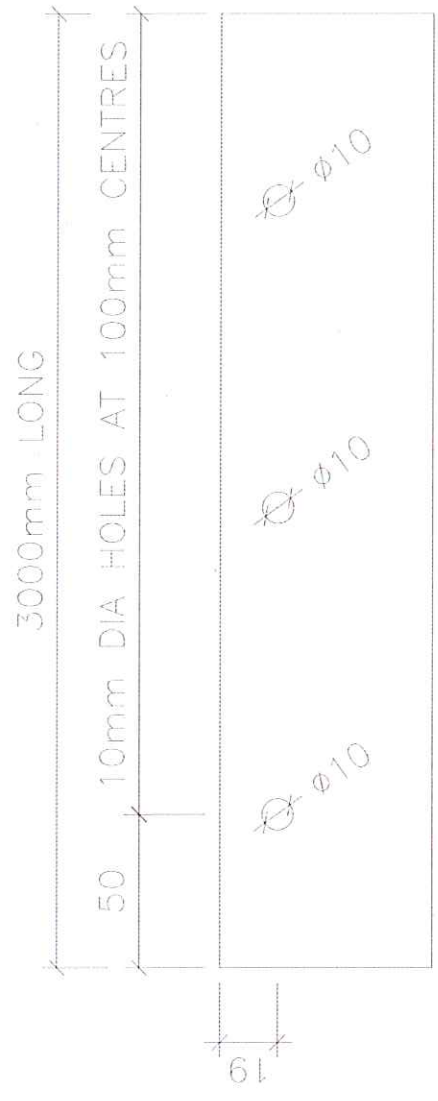
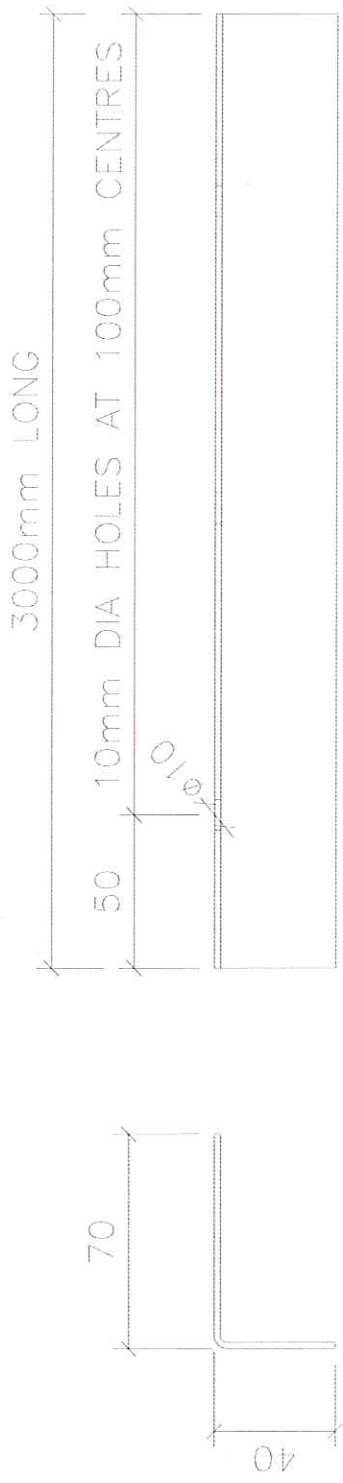

MATERIAL: 2mm ALUMINIUM GRADE 3103 H14 OR 5251 H22
FINISH: MILL

QUANTITY: 25No.

No.	Description	Qtd	Date



Kingspan Limited
Greenfield Business Park, No. 2, Greenfield,
Carrickmacross, Co. Du., UK
www.kingspaninsulation.co.uk
T: 0800 357 0090

Condensation Road,
Kingspan, Co. Carlin, Ireland
www.kingspaninsulation.ie
T: 00353 45 96 91229

Client
Kingspan

Project
BS8414 fire Test
Kingspan K15+Di-Design

Quantity
Aluminium Rail

Status



Drawn by	Checked by	Date
AC		06/06/16

Drawing No.	Revision
K15 - Di-Design D01547-11	2

The drawing is the property of Kingspan and
must be returned to Kingspan.

Notes:

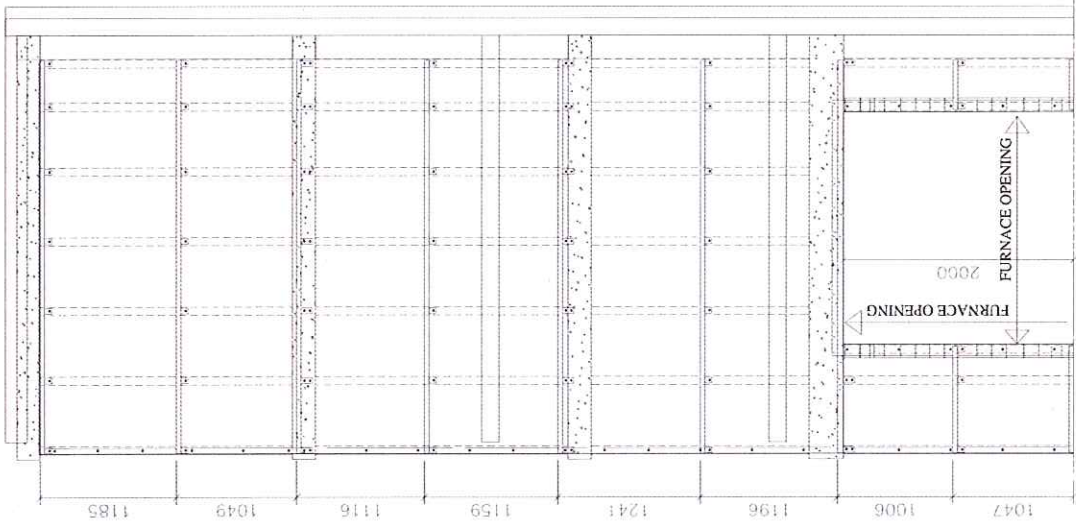

MAIN WALL ELEVATION

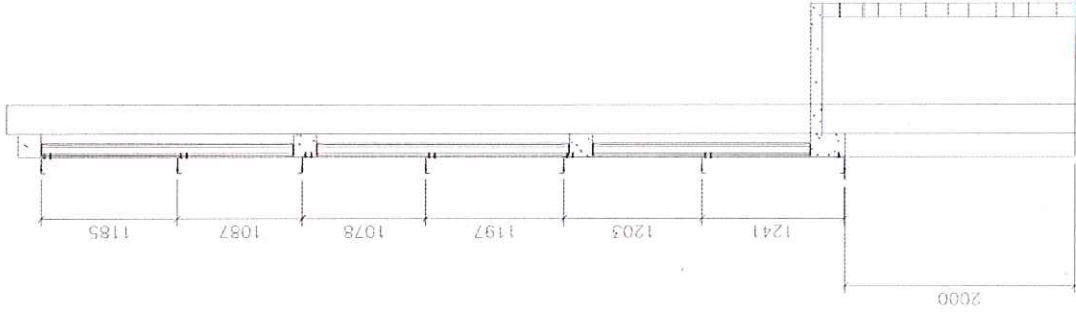

MAIN WALL SECTION

Facade Testing & Advisory Services Division

Rev	Description	Chd	Date



Kingspan Limited
 Greenfield Business Park, No. 2, Greenfield,
 Carrigrohane, Co. Cork, Ireland
 www.kingspanpanels.ie
 t: 0800 357 0090

Carrollmoyles Road,
 Kingscourt, Co. Cavan, Ireland
 www.kingspanpanels.ie
 t: 00353 42 96 91029

Client: Kingspan

Project:
 BS84-14 fire Test
 Kingspan K15+Dr+Design

Drawings:
 Support layout drawing
 Main Wall

Status:

Drawn by:	Checked by:	Date:
AC		03/09/13
Drawing Number:	Revision:	
K15 - Dr+Design DUT1507-12	2	

This drawing is the property of Kingspan and is not to be used for any other project without consent from Kingspan.

Notes:

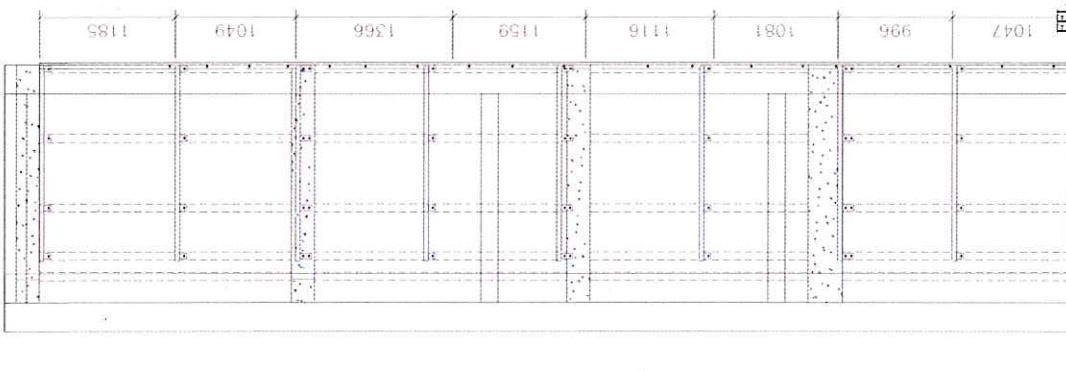

RETURN WALL ELEVATION

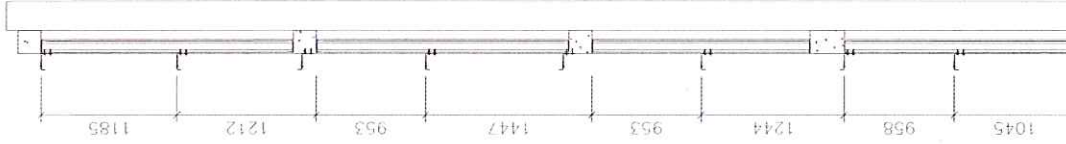

RETURN WALL SECTION



 Al-Futaim Exova

No.	Description	Chkd.	Date



Kingspan Limited
 Greenfield Business Park, No. 2, Greenfield,
 Carrigrohane, Co. Cork, Ireland
 www.kingspaninsulation.co.uk
 T: 0800 317 0090

Carrigrohane Road,
 Kingscourt, Co. Carrig,
 Ireland
 www.kingspanpanels.ie
 T: 00353 42 36 9020

Client:
Kingspan

Project:
BS8414 fire Test
Kingspan K15+Dr-Design

Drawing:
Support layout drawing
Return Wall

Scale:

Drawn by	Checked by	Date
AE	AE	00/04/10

Drawing Number	Revision
K15 - Dr-Design DB1542-13	2

This drawing is the property of Kingspan and
 shall remain confidential to Kingspan

Notes:

3407

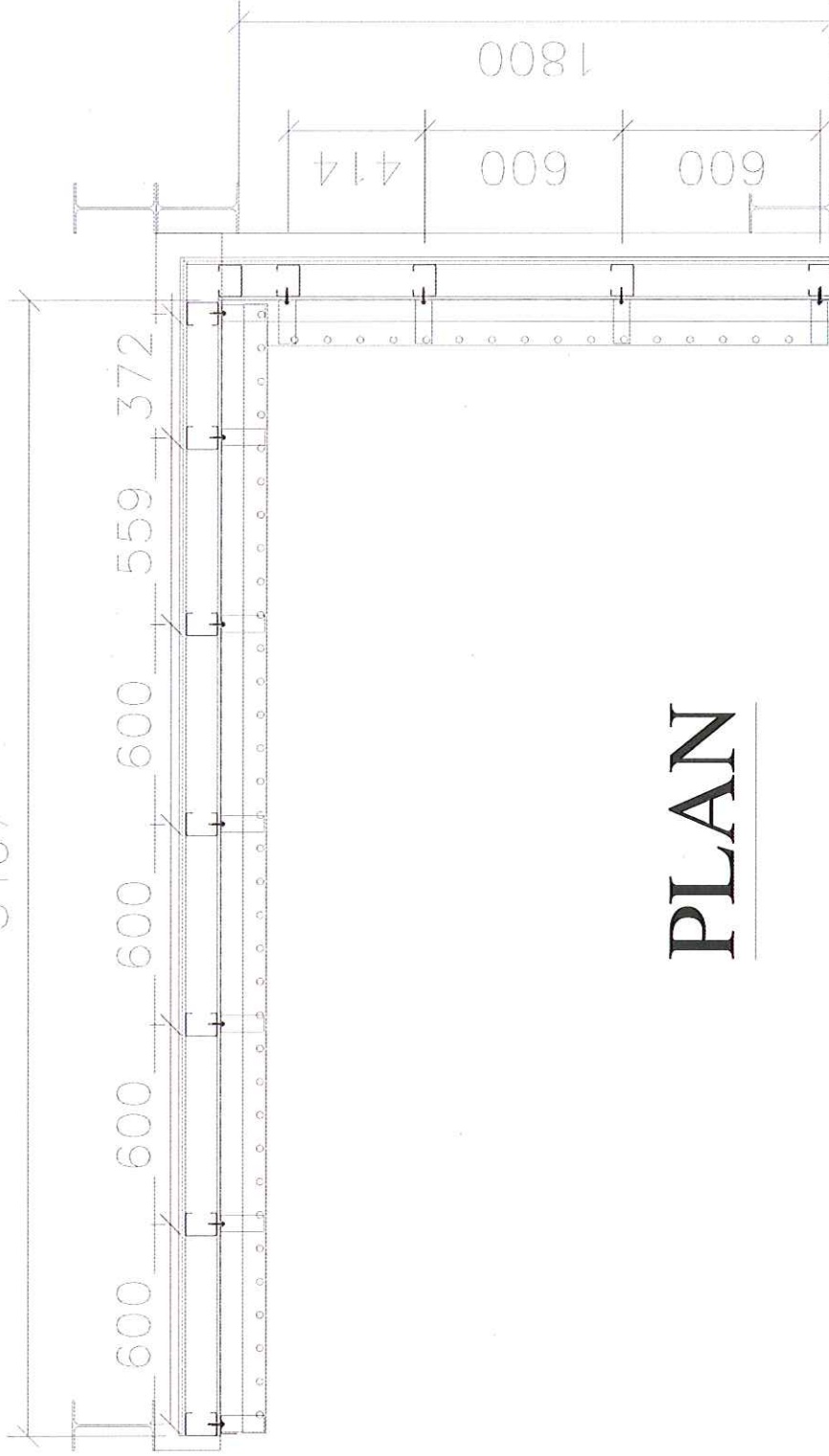

PLAN



Kingspan Limited
Greenfield Business Park, No. 2, Greenfield,
Hollywell, Liverpool, Merseyside, CH6 7JQ, UK
Tel: 0800 347 0090

Company No: 3421
Kingspan, Co. Cork, Ireland
www.kingspanpanels.ie
E: 00353 42 96 93209

Client

Kingspan

Project

BS8414 fire Test
Kingspan K15-DI-Design

Drawing

Support Layout drawing
Plan

Status

Drawn by	Checked by	Date
AC		06/09/18
Drawing Number	Revision	
K15 - Design DB1417-14	2	

This drawing is the property of Kingspan and
must be returned to Kingspan if
it is ever lost or stolen.



Notes

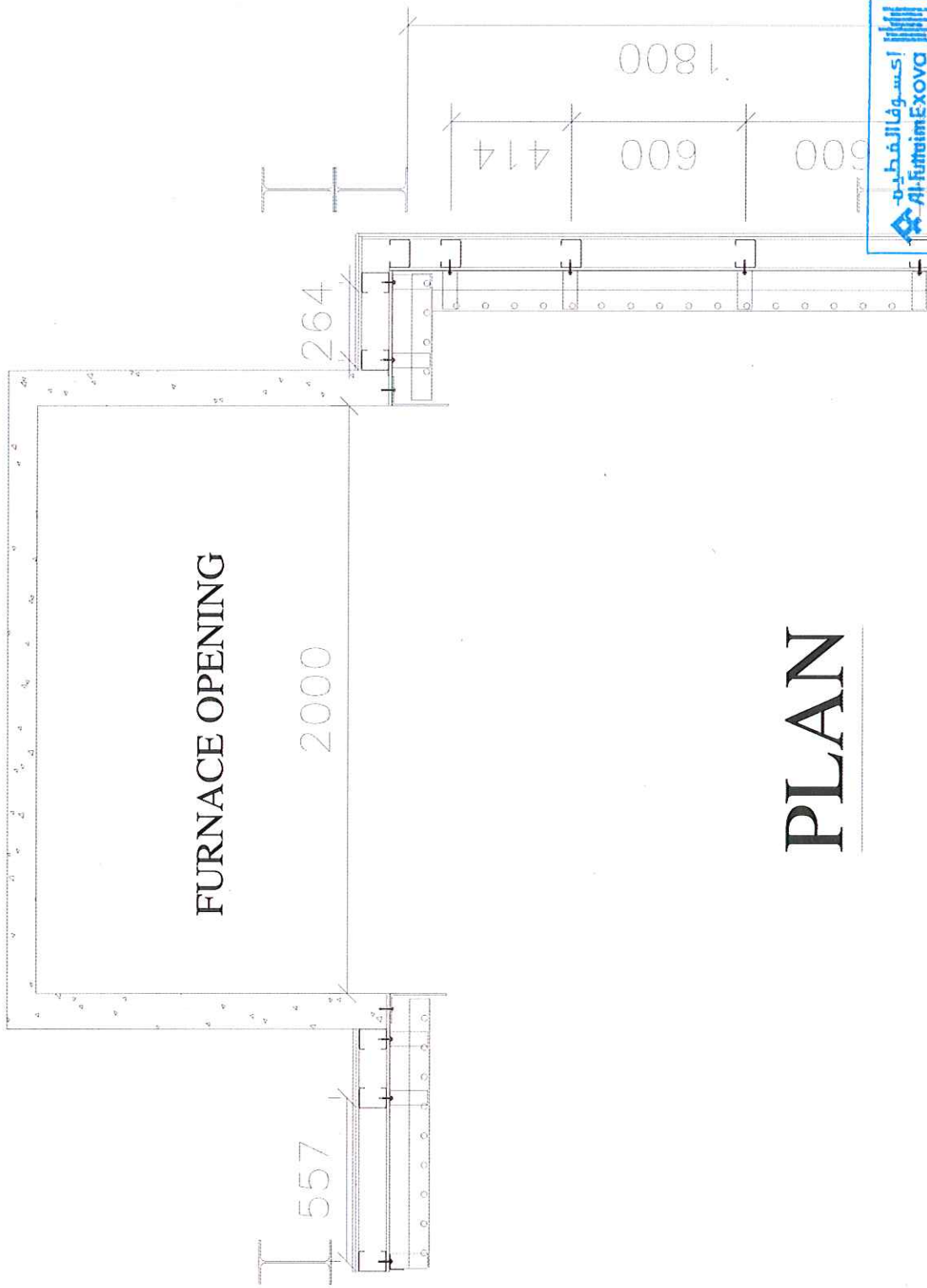

FURNACE OPENING

2000

557

1800

600

414

600

PLAN



Kingspan Limited
Greenfield Business Park, No. 2, Greenfield,
Holywell, Flintshire, CH8 7GJ, UK
www.kingspanpanels.ie

Constructional Steel
Kingspan, Co. Clontarf, Ireland
www.kingspanpanels.ie
t: 00353 42 96 9829

Client
Kingspan

Project
BS8414 fire Test
Kingspan K15-DH-Design

Drawing
Support Layout drawing
Plan

Drawn by	Checked by	Date
AE		06/09/18

Drawing number	Revision
K15 - DH-Design DR1547-15	2

This drawing is the property of Kingspan and
shall not be used for any other
purpose without the prior written
consent of Kingspan.

Notes:

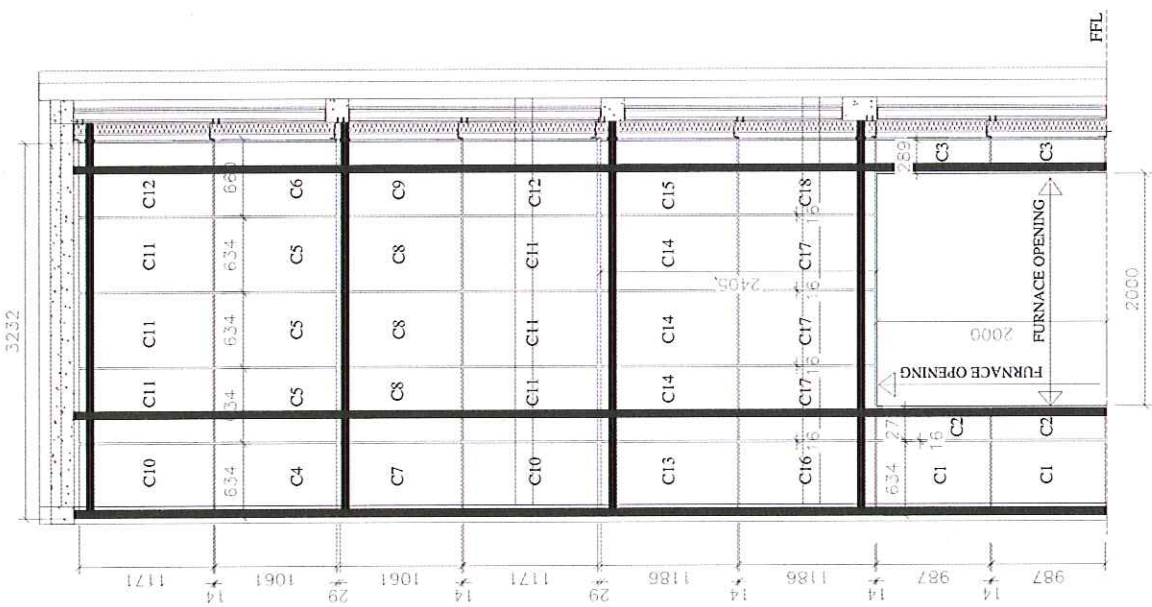

MAIN WALL ELEVATION

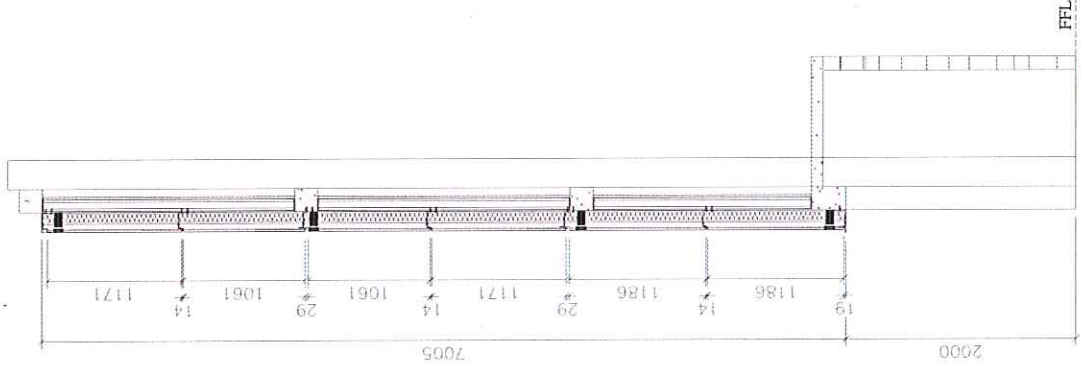

MAIN WALL SECTION



Al-Futurim EXOVG
Engineering & Advisory Services Division

Rev	Description	Chkd	Date



Kingspan Limited
Greenfield Business Park No. 2, Greenfield,
Holywell, Flintshire, CH8 7GJ, UK
www.kingspaninsulation.co.uk
T: 0800 547 0090

Carmelton Road, Ireland
www.kingspaninsulation.ie
T: 00353 43 96 91250

Client: Kingspan

Project: BSS414 fire Test
Kingspan K15+Di-Design

Drawing: Cassette layout drawing
Main Wall

Drawn By: AE	Checked By:	Date: 08/09/10
Drawing Number: K15 + Di-Design DLR1547-16	Revision: 2	

This drawing is the property of Kingspan and shall not be used for any other purpose without the prior written consent of Kingspan.

Notes:

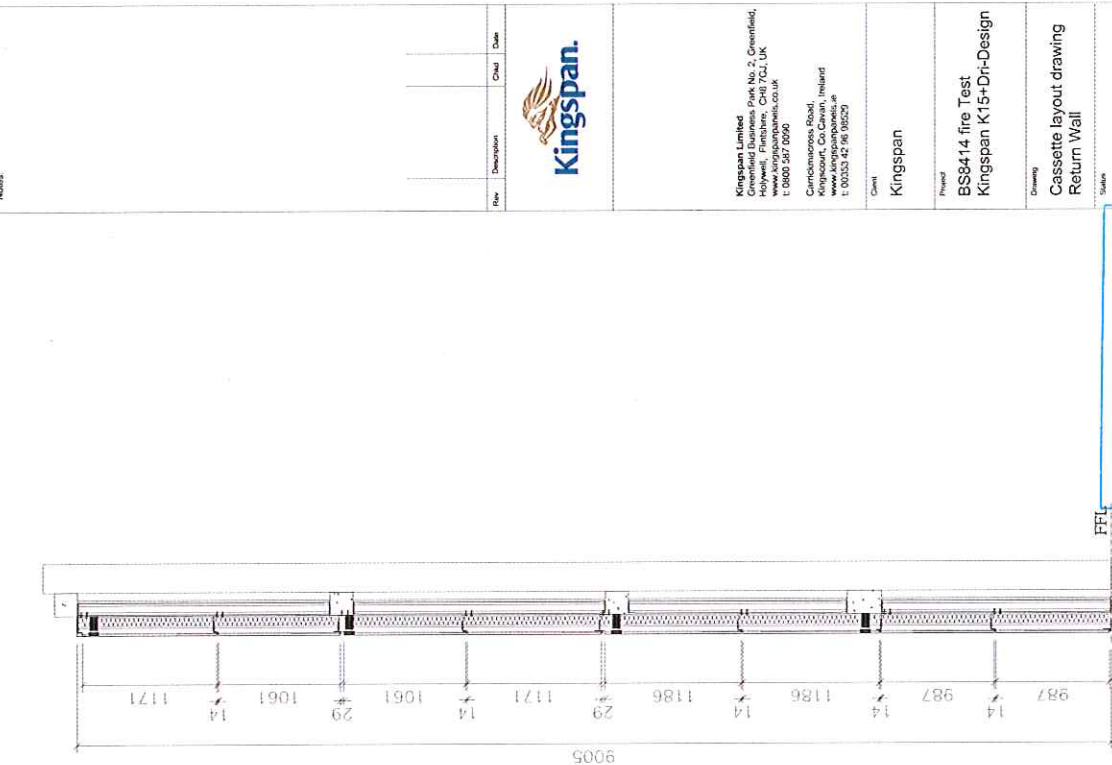

RETURN WALL ELEVATION

Facade Testing & Advisory Services Division

RETURN WALL SECTION

Rev	Description	Chgd	Date



Kingspan Limited
 Greenfield Business Park No. 2, Greenfield,
 Holywell, Flintshire, CH8 7GJ, UK
 Tel: 0800 347 0690

Kingspan Middle East
 20th Floor, The Capital Centre,
 Sheikh Mohammed Bin Rashid City,
 Dubai, UAE
 Tel: 00971 4 38 98529

Client:
Kingspan

Project:
BS8414 fire Test
Kingspan K15+Dr+Design

Drawing:
Cassette layout drawing
Return Wall

Drawn By	Checked by	Date
AE		09/09/19

Drawing Number	Revision
K15 - Dr+Design DBR17-17	2

This drawing is the property of Kingspan and is not to be used for any other project without consent from Kingspan.

Notes:

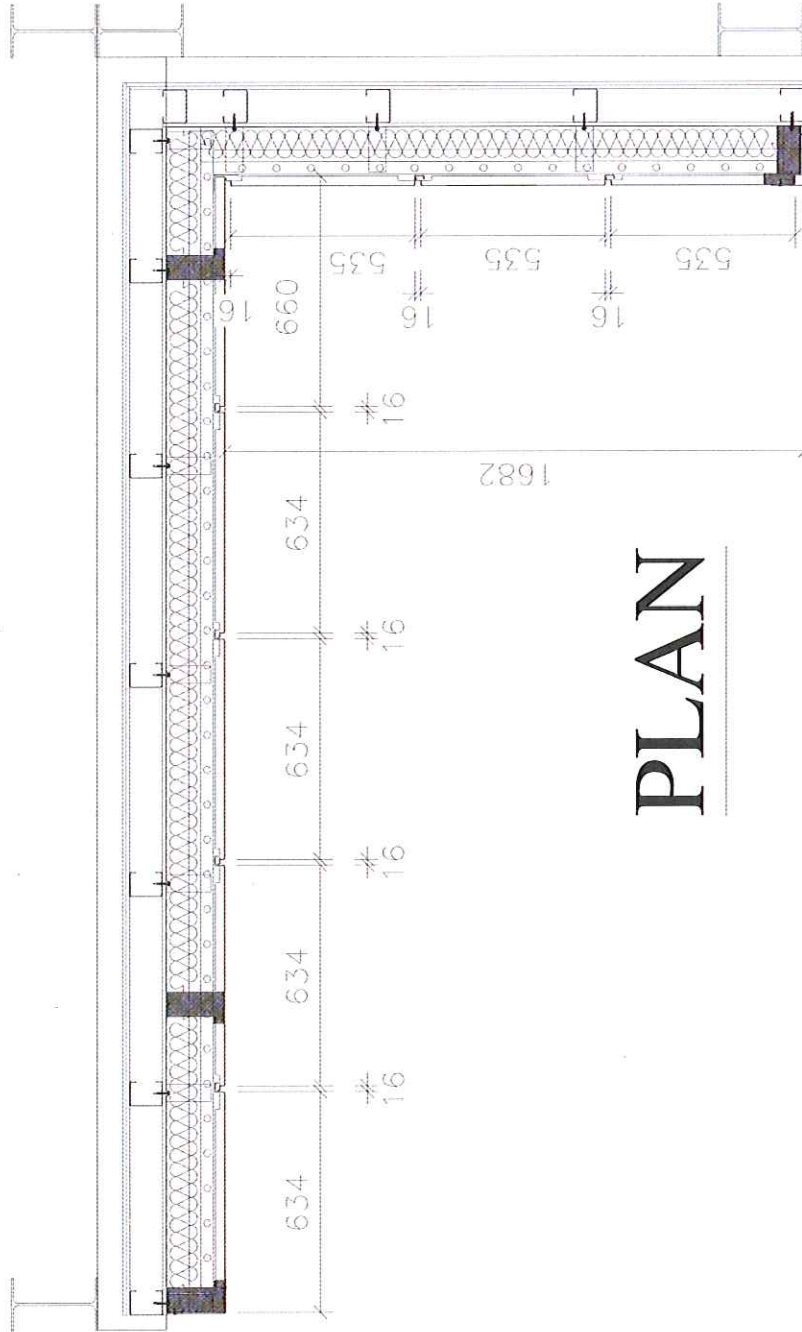

PLAN

Rev	Description	Date



Kingspan Limited
 Greenfield Business Park No. 2, Greenfield,
 Holywell, Flintshire, CH8 7GJ, UK
 Tel: 01890 547 0300

Cardiff Business Park
 Cardiff, Wales
 www.kingspanpanels.ie
 Tel: 00353 42 96 98529

Client
Kingspan

Project
**BS8414 fire Test
 Kingspan K15+Di-Design**

Drawing
**Cassette Layout drawing
 Plan**

Status

Drawn By	Checked by	Date
AE		08/09/18

Drawing Number	Revision
K15 - Di-Design DLR147-19	2



This drawing is the property of Kingspan and is not to be used for any other purpose without the prior written consent of Kingspan.

Notes:

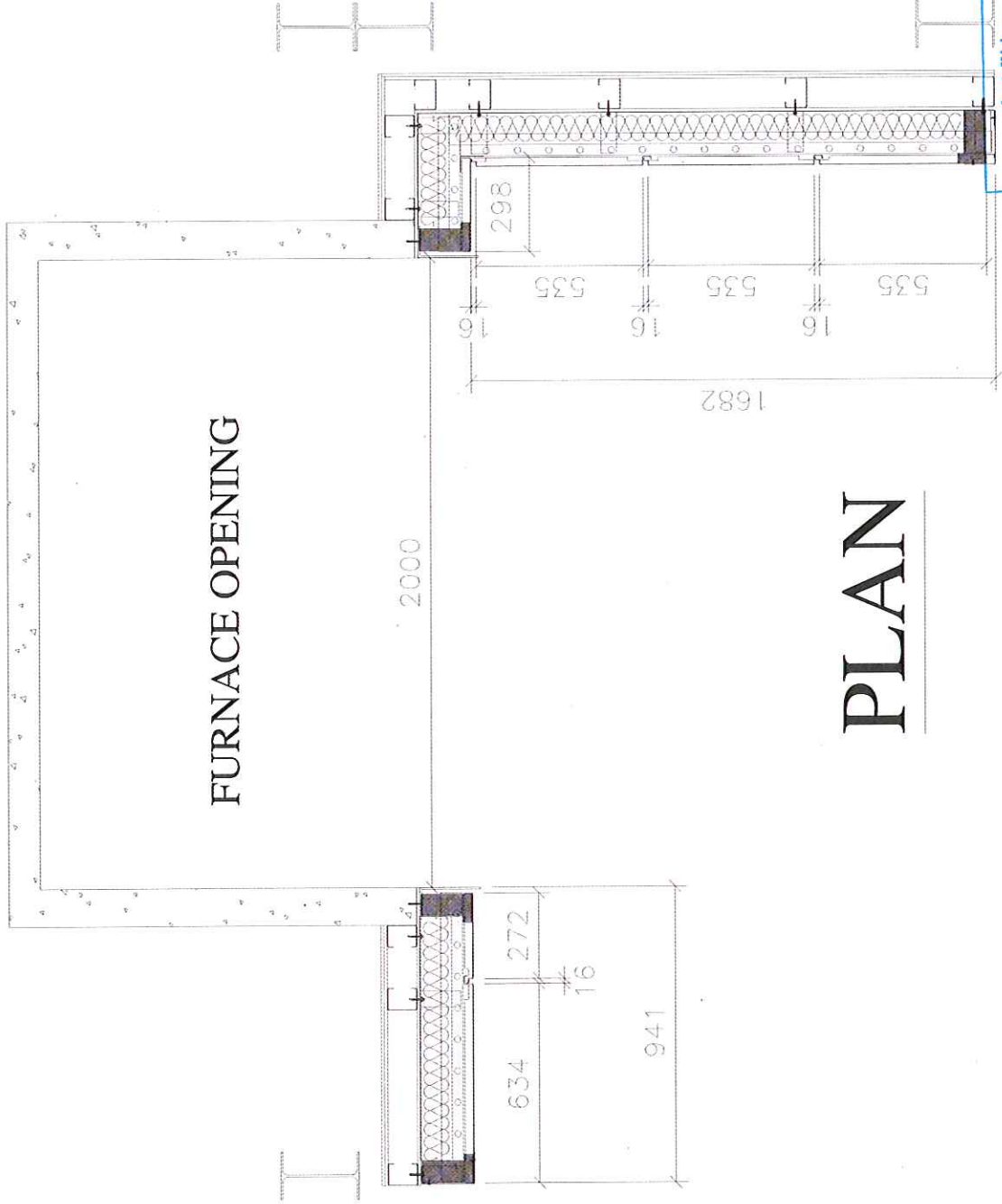

FURNACE OPENING

PLAN

No. Description Chd. Date



Kingspan Limited
Greenfield Business Park No. 2, Greenfield,
Kingspan Road, Carrigrohane, Co. Cork, Ireland
www.kingspanpanels.co.uk
T: 0800 347 0990

Carrigrohane Road,
Kingspan, Co. Cork, Ireland
www.kingspanpanels.ie
T: 0353 42 46 3525

Client
Kingspan

Project
BS8414 fire Test
Kingspan K15+Dr-Design

Category
Cassette Layout drawing
Plan

Status

Drawn by	Checked by	Date
AC		09/09/10
Revision Number	Revision	
K15 + Dr-Design DR1547-19	2	

This drawing is the property of Kingspan and will be returned to Kingspan.



AL FUTTAIM EXOVA LLC

Façade Testing & Advisory Services

PO Box 34924

Dubai Investments Park

Dubai – United Arab Emirates

T: + 971 4 886 8715 F: + 971 4 885 6795

© Al Futtaim Exova (AFE) LLC - Façade Testing & Advisory Services 2018

This report is made by AFE and shall only be distributed in its entirety and with no deviation. It relates only to the actual sample as tested and described herein. AFE has no responsibility for the design, materials, workmanship or performance of the product / sample tested.

This report does not constitute approval, certification or endorsement of the product / system tested and no such claims to this should be made. The report is personal to the client, confidential, non-assignable and shall not be reproduced, except in full.

The document may only be used for the purposes for which it was commissioned and in accordance with the terms and conditions for the commission. AFE shall have no liability to third parties to the extent permitted in law. Unauthorised use of this document in any form whatsoever is prohibited.

Table 5 Document Status

Rev No.	Author	Reviewed & Approved for Issue		
		Name	Signature	Date
0	Arun Kumar M	Manoj Kumar Lab. Manager		29.11.15